

<b>Customer Approved</b>
<b>Date:</b>

**Part No.:**  
**LB170XB1C-C01T3**

**DATA SHEET**

Issue Date: 2019.01.30  
Issue No.: LTD-170X-001  
REVISION: V3

Designer	Checker	Approver
<i>Lisa</i>	<i>Rock</i>	<i>Allen</i>

SMD Type ■ Top view 0805 Package  
LB170XB1C-C01T3

Features

- 0805 package
- Top view LED
- Compatible with infrared and vapor phase reflow solder process
- Pb-free
- RoHS compliant

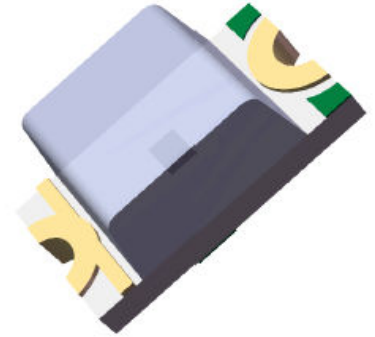

Package Dimensions

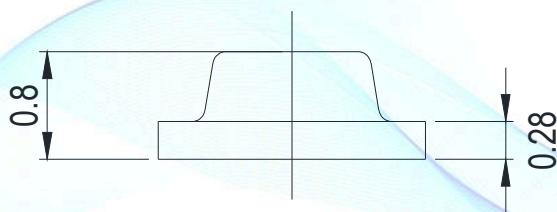
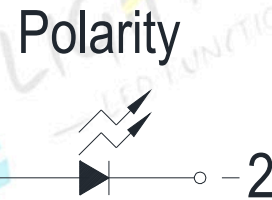
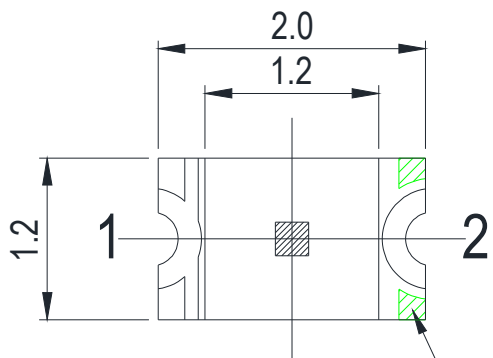

Recommended Solder Pad

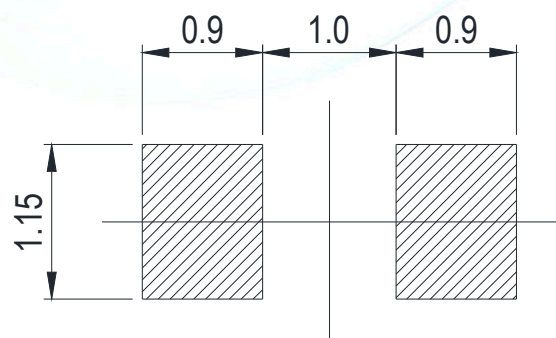
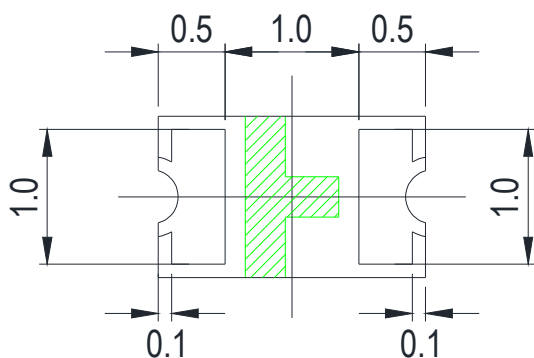

Note:  
Tolerance unless mentioned is  $\pm 0.1$ mm, Unit = mm.

### Applications

- Indoor signage display applications
- Indoor decorating and design
- Signal and Symbol Luminary
- Automotive Telecommunication
- Switch lights

### Device Selection Guide

Emitted Color	Resin Color
Blue	Water Clear

### Absolute Maximum Ratings (T<sub>Soldering</sub>=25°C)

Parameter	Symbol	Rating	Unit
Forward Current	I <sub>F</sub>	25	mA
Peak Forward Current (Duty 1/10 @1ms)	I <sub>FP</sub>	60	mA
Power Dissipation	P <sub>d</sub>	95	mW
Operating Temperature	T <sub>opr</sub>	-40 ~ +85	°C
Storage Temperature	T <sub>stg</sub>	-40 ~ +100	°C
Soldering Temperature	T <sub>sol</sub>	Reflow Soldering : 260°C for 10 sec. Hand Soldering : 350°C for 3 sec.	
Reverse Voltage	V <sub>R</sub>	5	V

Note:  
The products are sensitive to static electricity and must be carefully taken when handling products.

### Electro-Optical Characteristics (T<sub>Soldering</sub>=25°C)

Parameter	Symbol	Min.	Typ.	Max.	Unit	Condition
Luminous Intensity	I <sub>v</sub>	30.0	-	89.0	mcd	I <sub>F</sub> =5mA
Dominant Wavelength	λ <sub>D</sub>	460.0	-	472.5	nm	I <sub>F</sub> =5mA
Forward Voltage	V <sub>F</sub>	2.6	-	3.0	V	I <sub>F</sub> =5mA
Viewing Angle	2θ <sub>1/2</sub>	-	140	-	deg	I <sub>F</sub> =5mA
Reverse Current	I <sub>R</sub>	-	-	1	μA	V <sub>R</sub> =5V

- Notes:
1. Tolerance of Luminous Intensity ±10%.
  2. Tolerance of Dominant Wavelength : ±1nm.
  3. Tolerance of Forward Voltage : ±0.05V.

## Bin Code Description

### Bin Range of Luminous Intensity

Bin Code	Min.	Max.	Unit	Condition
K	30.0	43.0	mcd	I <sub>F</sub> =5mA
l	43.0	62.0		
m	62.0	89.0		

### Bin Range of Dominant Wavelength

Bin Code	Min.	Max.	Unit	Condition
B5	460.0	462.5	nm	I <sub>F</sub> =5mA
B6	462.5	465.0		
B7	465.0	467.5		
B8	467.5	470.0		
B9	470.0	472.5		

### Bin Range of Forward Voltage

Bin Code	Min.	Max.	Unit	Condition
33	2.6	2.7	V	I <sub>F</sub> =5mA
34	2.7	2.8		
35	2.8	2.9		
36	2.9	3.0		

#### Notes:

1. Tolerance of Luminous Intensity  $\pm 10\%$ .
2. Tolerance of Dominant Wavelength :  $\pm 1\text{nm}$ .
3. Tolerance of Forward Voltage :  $\pm 0.05\text{V}$ .

**Typical Electro-Optical Characteristics Curves**

Fig.1-Forward Current(V) vs. Forward Voltage  $T_s=25^\circ\text{C}$

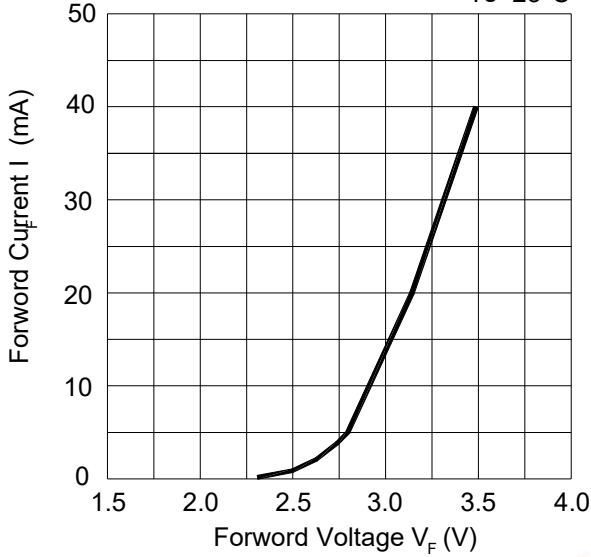

Fig.2-Relative Luminous Intensity vs. Forward Current  $T_s=25^\circ\text{C}$

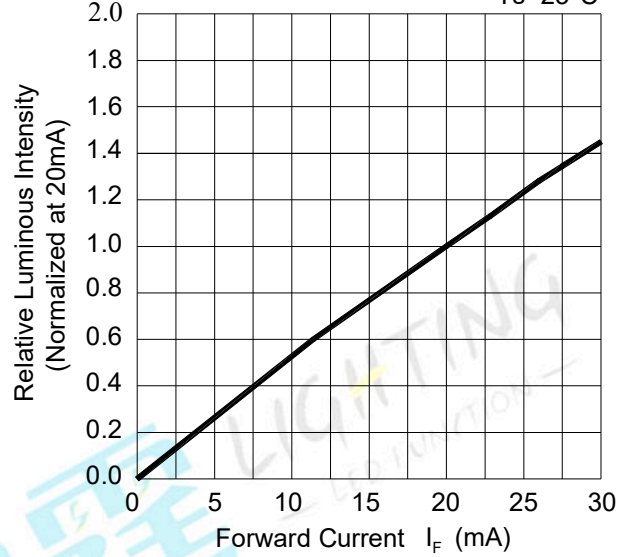

Fig.3-Max.Driving Forward Current vs.Soldering Temperature

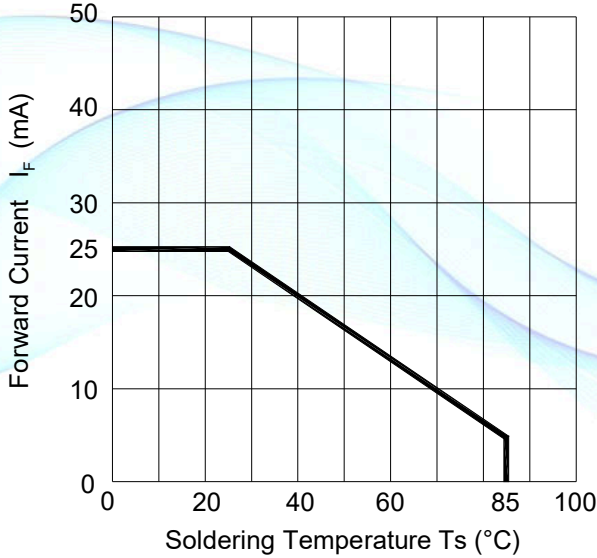
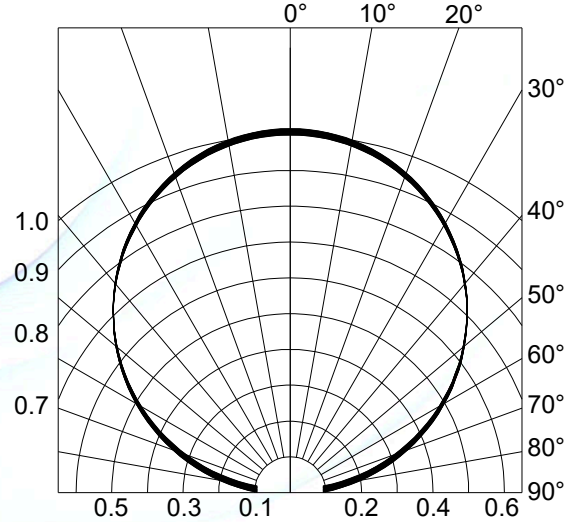

Fig.4-Radiation Diagram  $T_a=25^\circ\text{C}$



**Typical Electro-Optical Characteristics Curves**

Fig.5-Forward Voltage Shift vs. Junction Temperature

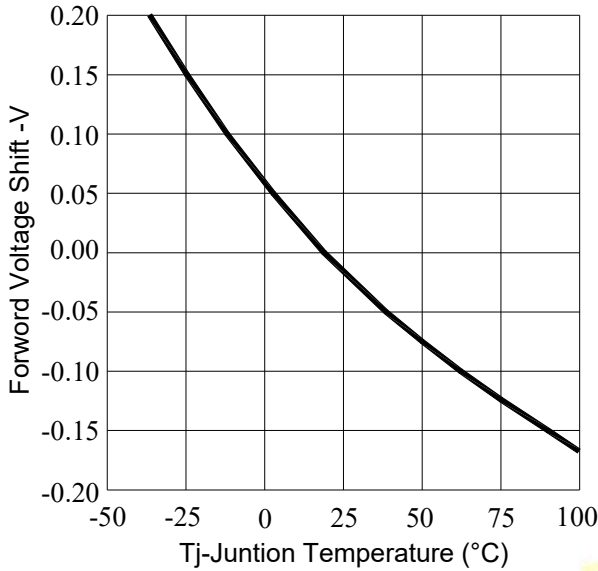
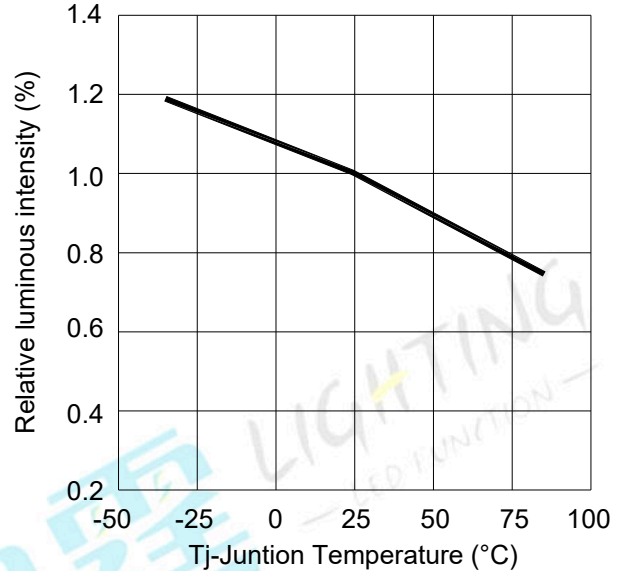
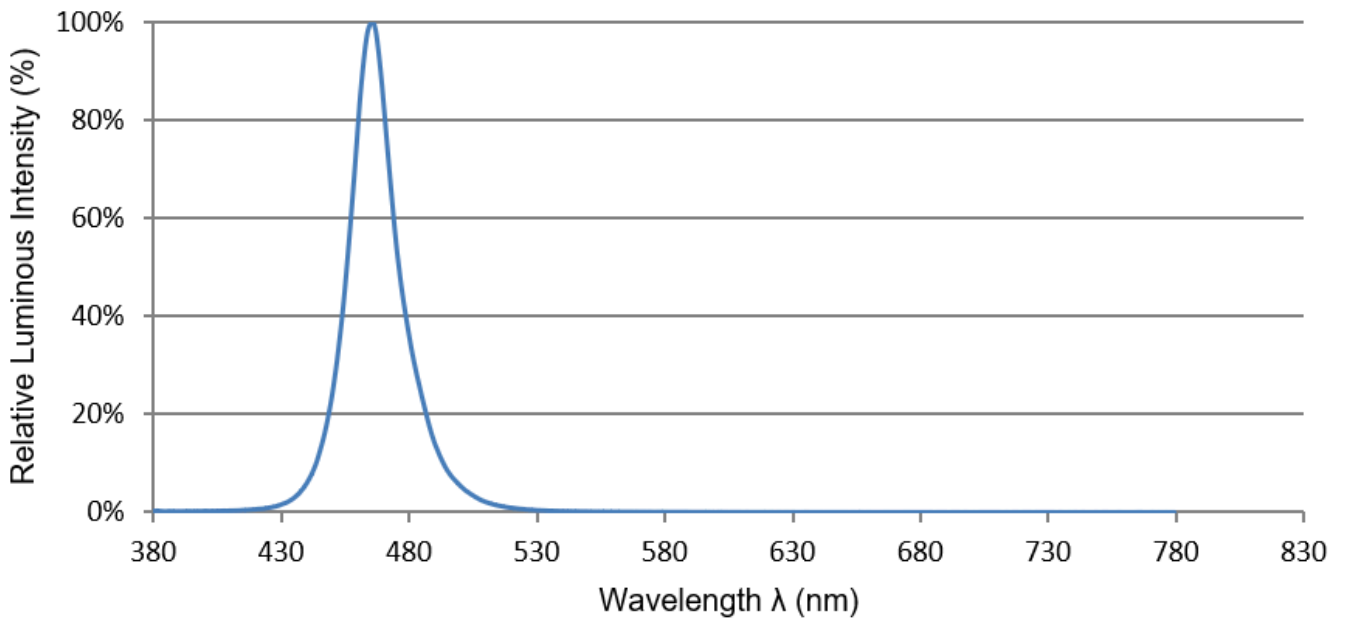

Fig.6-Relative Luminous Intensity vs. Junction Temperature



**Spectrum Distribution**



**Moisture Resistant Packing Materials  
Label Explanation**



- \* QR code:  
Contains all of the following information
- \* P/N: Product Number
- \* TYPE :Part NO.
- \* IV: Luminous Intensity Rank
- \* WD: Dom. Wavelength Rank
- \* VF: Forward Voltage Rank
- \* QTY: Packing Quantity
- \* LOT NO.: Lot Number

**Taping method: Loaded Quantity 3,000 pcs Per Reel**

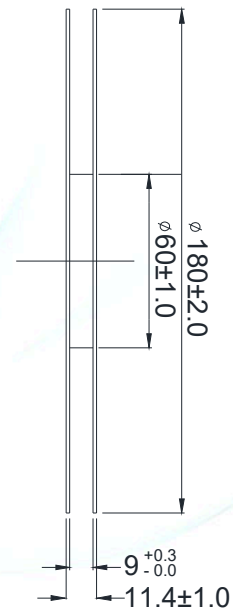
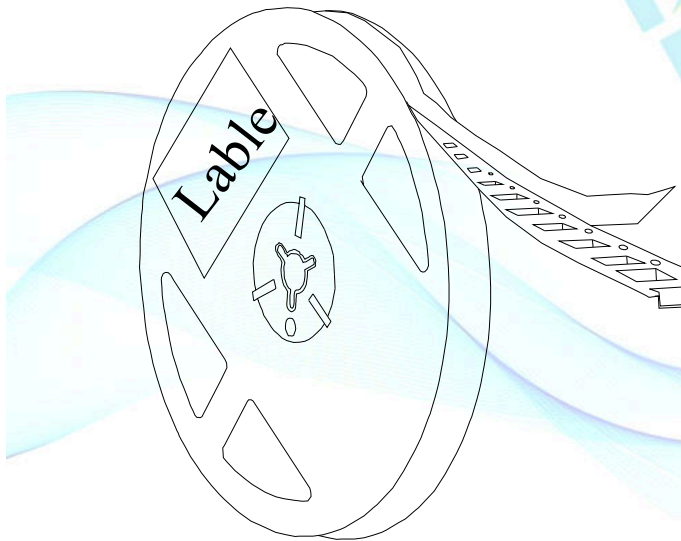

**Direction of unreeling** →

- Notes:
1. Tolerance unless mentioned is ±0.1mm, Unit = mm.
  2. Minimum packing amount is 1000 pcs per reel.

**Carrier Tape Dimensions:**

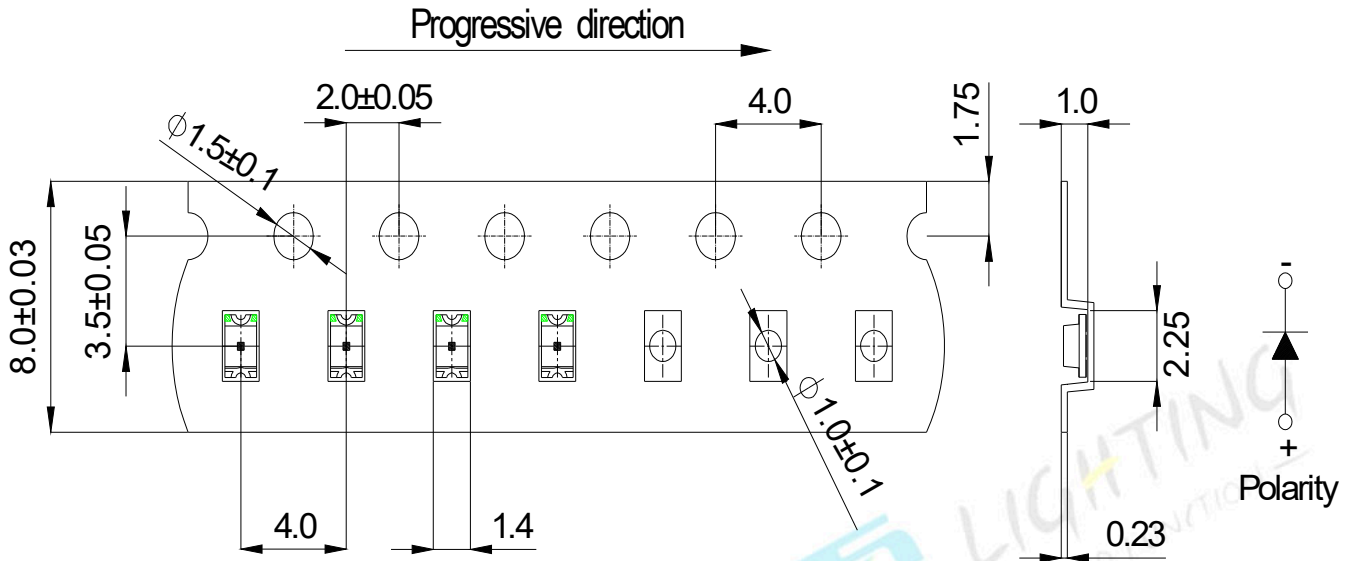

Note:  
Tolerance unless mentioned is  $\pm 0.1$ mm, Unit = mm.

**Moisture Resistant Packing Process**

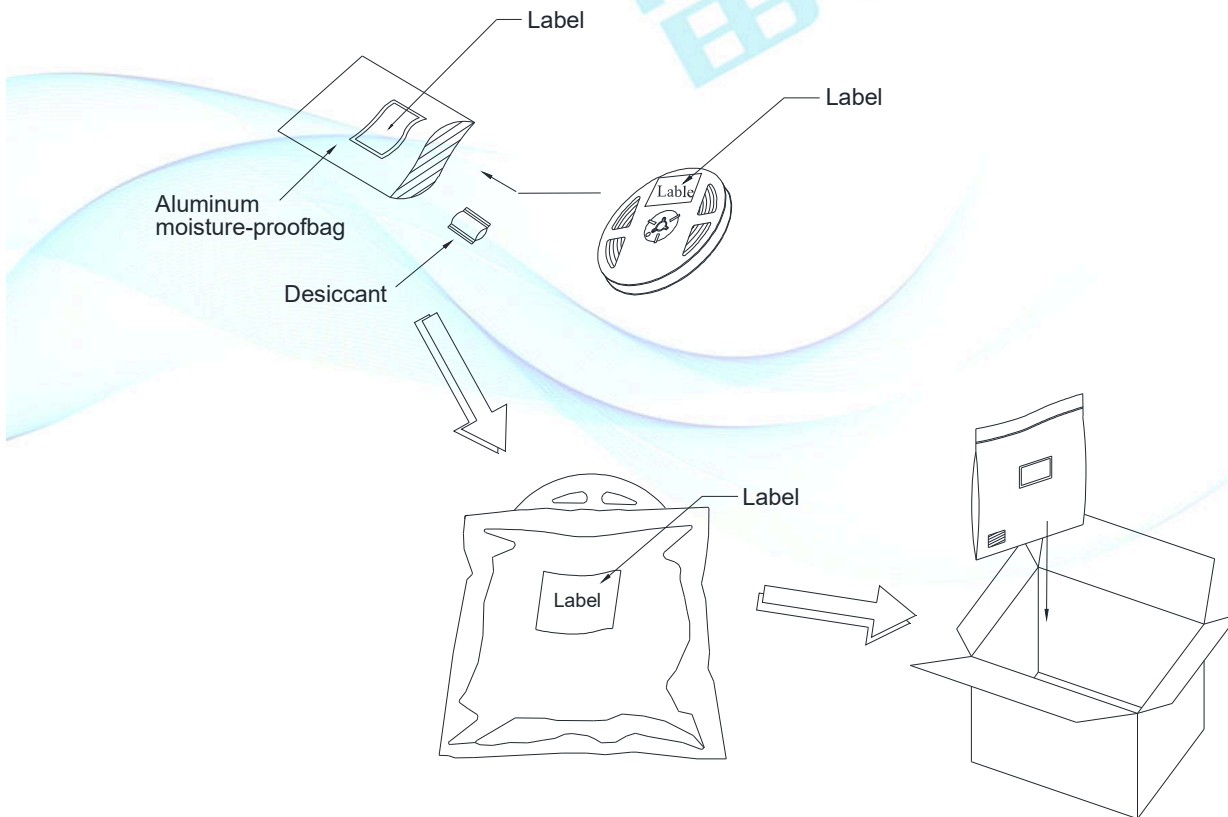

Moisture/Reflow sensitivity classification  
IPC / JEDEC J-STD-020C: Level 2



## Reliability Test Items and Conditions

The reliability of products shall be satisfied with items listed below.

Confidence level : 90%

LTPD : 10%

No.	Items	Test Condition	Test Hours/Cycles	Sample Size	Ac/Re
1	Reflow Soldering	Temp.: 260°C/10sec.	6 Min.	22 PCS.	0/1
2	Thermal Shock	H : +100°C/5min § 10 sec L : -10°C/5min	300 Cycles	22 PCS.	0/1
3	Temperature Cycle	H : +100°C/15min § 5 min L : -40°C/15min	300 Cycles	22 PCS.	0/1
4	High Temperature/Humidity Storage	Ta=85°C,85%RH	1000 Hrs.	22 PCS.	0/1
5	Low Temperature Storage	Ta=-40°C	1000 Hrs.	22 PCS.	0/1
6	High Temperature Storage	Ta=100°C	1000 Hrs.	22 PCS.	0/1
7	DC Operation Life	Ta=25°C, I <sub>F</sub> = 5 mA	1000 Hrs.	22 PCS.	0/1

## Precautions for Use

### 1. Over-current-proof

Customer must apply resistors for protection; otherwise slight voltage shift will cause big current change (Burn out will happen).

### 2. Storage

2.1 Do not open moisture proof bag before the products are ready to use.

2.2 Before opening the package: The LEDs should be kept at 30°C or less and 90%RH or less.

2.3 After opening the package: The LED's floor life is 1 year under 30°C or less and 60%RH or less. If unused LEDs remain, it should be stored in moisture proof packages.

2.4 If the moisture absorbent material (silica gel) has faded away or the LEDs have exceeded the storage time, baking treatment should be performed using the following conditions.

Baking treatment: 60±5°C for 24 hours.

### 3. Soldering Condition

#### 3.1 Pb-free solder temperature profile

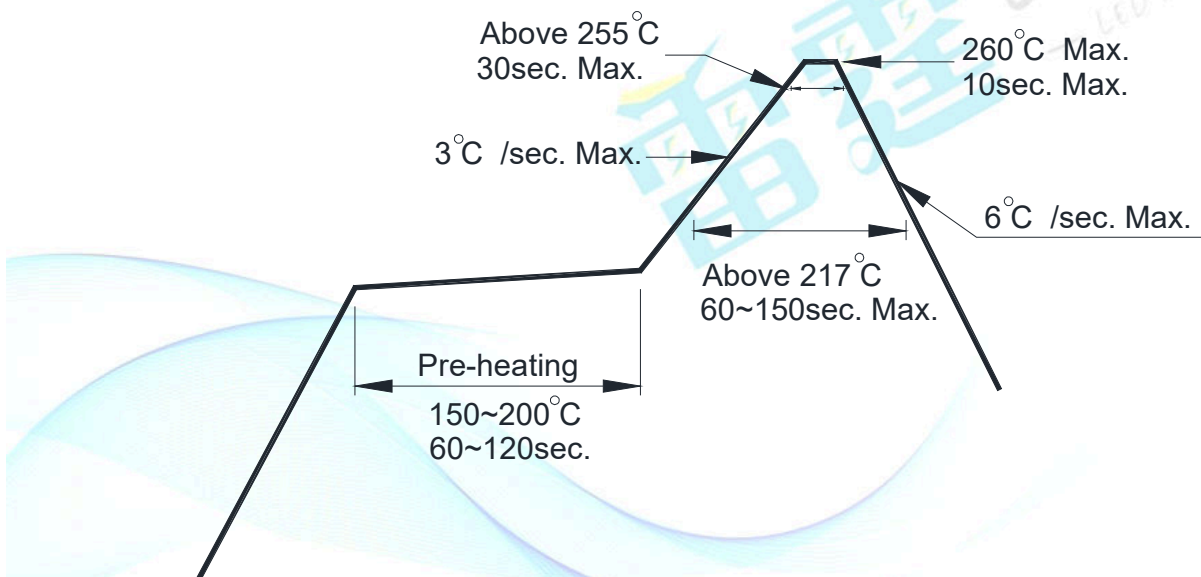

3.2 Reflow soldering should not be done more than two times.

3.3 When soldering, do not put stress on the LEDs during heating.

3.4 After soldering, do not warp the circuit board.

### 4. Soldering Iron

Each terminal is to go to the tip of soldering iron temperature less than 350°C for 3 seconds within once in less than the soldering iron capacity 25W. Leave two seconds and more intervals and do soldering of each terminal. Be careful because the damage of the product is often started at the time of the hand solder.

### 5. Repairing

Repair should not be done after the LEDs have been soldered. When repairing is unavoidable, a double-head soldering iron should be used (as below figure). It should be confirmed beforehand whether the characteristics of the LEDs will or will not be damaged by repairing.