

Customer Approved
Date:

Part No.:
LL836W1D-HN1T4

DATA SHEET

Issue Date: 2018.09.07

Issue No.: LTD-836-007

REVISION: V3

Designer	Checker	Approver
<i>Lisa</i>	<i>Rock</i>	<i>Allen</i>

SMD Type ■ Top view 2835 Package
LL836W1D-HN1T4

Features

- 2835 package
- Top view LED
- High luminous flux output
- Compatible with infrared and vapor phase reflow solder process
- Pb-free
- RoHS compliant

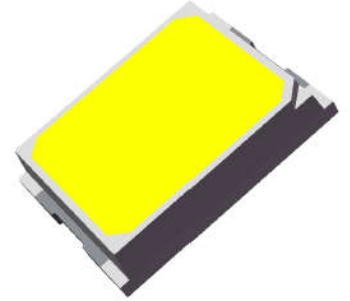

Package Dimensions

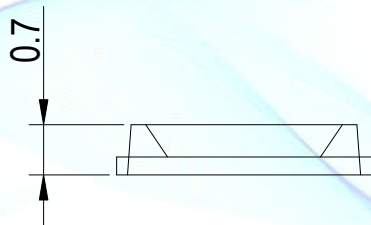
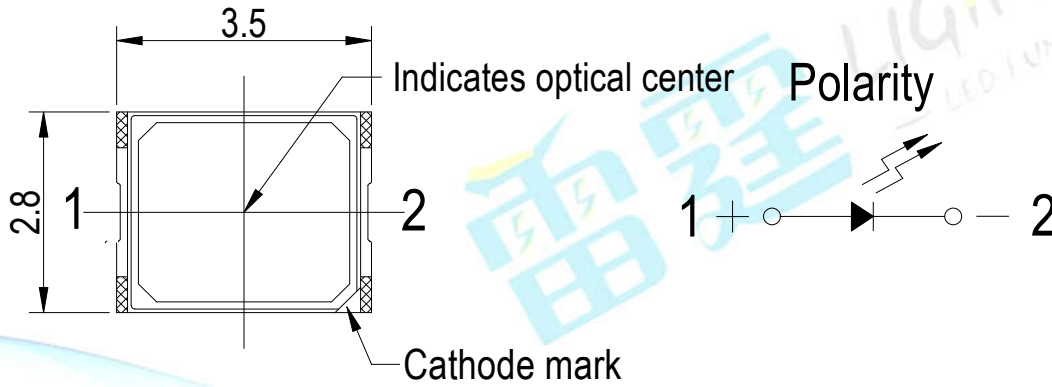

Recommended solder pad

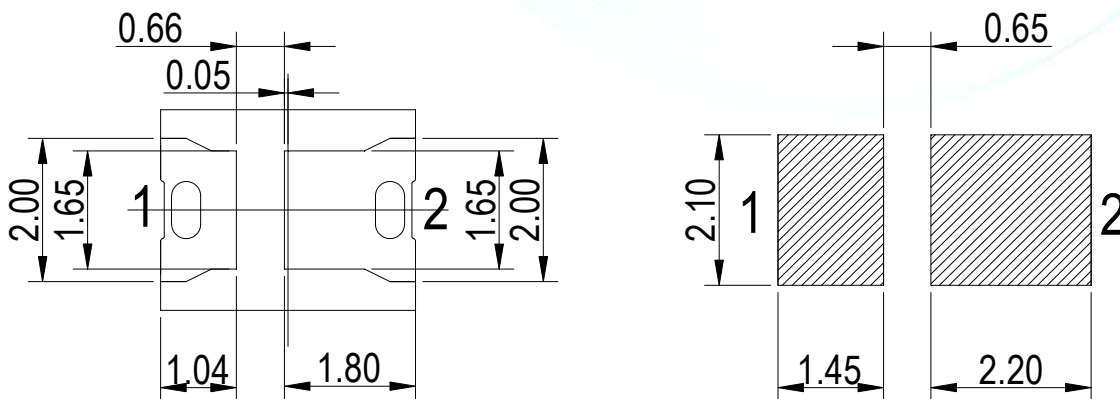

Note:
Tolerance unless mentioned is ± 0.1 mm, Unit = mm.

Applications

- Flash lights
- General lighting
- Decorative and Entertainment Lighting
- Indicators
- Illumination
- Automotive Telecommunication
- Switch lights

Device Selection Guide

Emitted Color	Resin Color
White	Yellow Diffused

Absolute Maximum Ratings (T_{Soldering}=25°C)

Parameter	Symbol	Rating	Unit
Forward Current	I _F	150	mA
Peak Forward Current (T=1ms, tp=0.1ms)	I _{FP}	180	mA
Power Dissipation	P _d	0.5	W
Operating Temperature	T _{opr}	-40 ~ +85	°C
Storage Temperature	T _{stg}	-40 ~ +100	°C
Soldering Temperature	T _{sol}	Reflow Soldering : 260 °C for 10 sec. Hand Soldering : 350 °C for 3 sec.	
Reverse Voltage	V _R	5	V

Note:

The products are sensitive to static electricity and must be carefully taken when handling products.

Electro-Optical Characteristics (T_{Soldering}=25°C)

Parameter	Symbol	Min.	Typ.	Max.	Unit	Condition
Luminous Flux	Φ	28	-----	32	lm	I _F =60mA
Forward Voltage	V _F	2.8	-----	3.2	V	I _F =60mA
Color Temperature	T _c	3800	-----	4300	K	I _F =60mA
Ra	----	80	-----	-----	-----	I _F =60mA
Viewing Angle	2θ _{1/2}	-----	120	-----	deg	I _F =60mA
Reverse Current	I _R	-----	-----	5	μA	V _R =5V

Notes:

1. Tolerance of Luminous Flux: ±10%.
2. Color Temperature ±100K.
3. Tolerance of Forward Voltage : ±0.05V.

Bin Code Description

Bin Range of Forward Voltage

Bin Code	Min.	Max.	Unit	Condition
35	2.8	2.9	V	I _F =60mA
36	2.9	3.0		
37	3.0	3.1		
38	3.1	3.2		

Note:

Tolerance of Forward Voltage : ±0.05V.

Bin Range of Chromaticity Coordinates

CCT	Bin Code	CIE-X	CIE-Y
4000K	R40-3	0.3823	0.3900
		0.3888	0.3852
		0.3777	0.3700
		0.3712	0.3748
		Reference Range: SDCM<3	
		0.3831	0.3933
	R40-4	0.3916	0.3871
		0.3768	0.3668
		0.3683	0.3731
		Reference Range: SDCM<4	
		0.3838	0.3966
		0.3943	0.3889
R40-6	0.3759	0.3636	
	0.3654	0.3713	
	Reference Range: SDCM<6		

Notes:

1. The value is based on driving current by 60mA.
2. Tolerance of Chromaticity Coordinates: ±0.01.

The C.I.E. 1931 Chromaticity Diagram

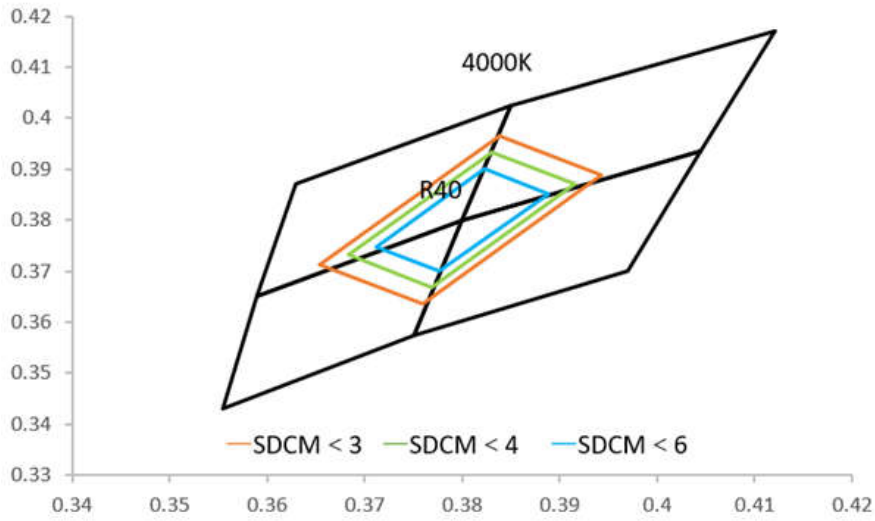

Typical Electro-Optical Characteristics Curves

Fig.1-Forward Current(I_F) vs. Forward Voltage (V) $T_s=25^{\circ}\text{C}$

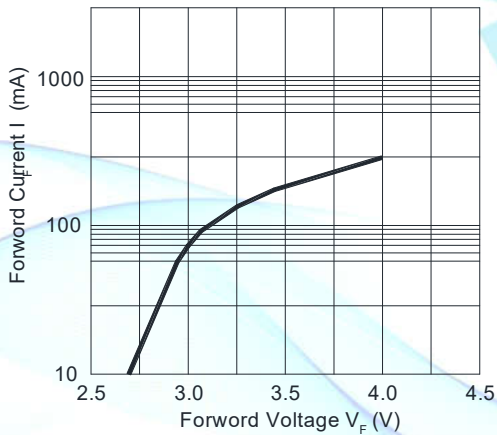

Fig.2-Relative Luminous Flux vs. Forward Current $T_s=25^{\circ}\text{C}$

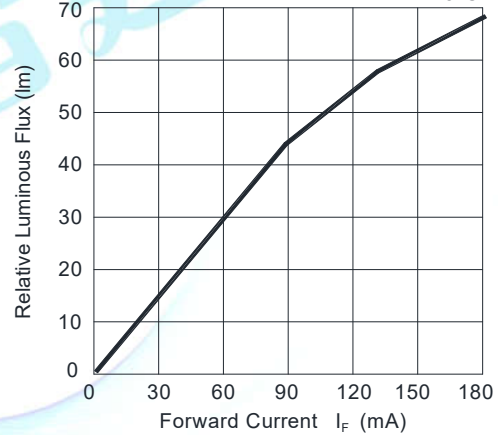

Fig.3-Max. Driving Forward Current vs. Soldering Temperature

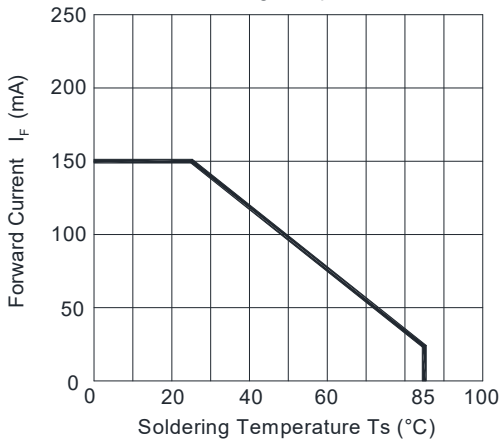
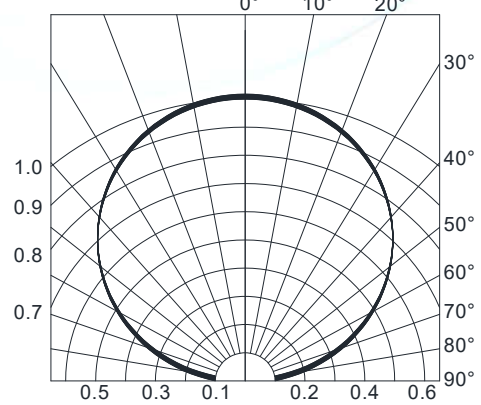

Fig.4-Radiation Diagram $T_a=25^{\circ}\text{C}$



Typical Electro-Optical Characteristics Curves

Fig.5-Forward Voltage Shift vs. Junction Temperature

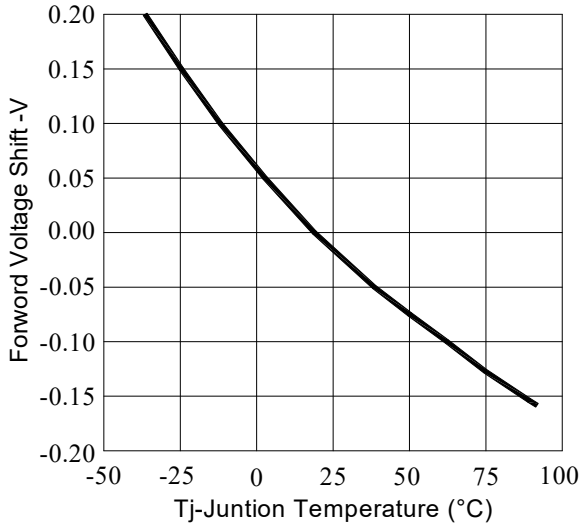
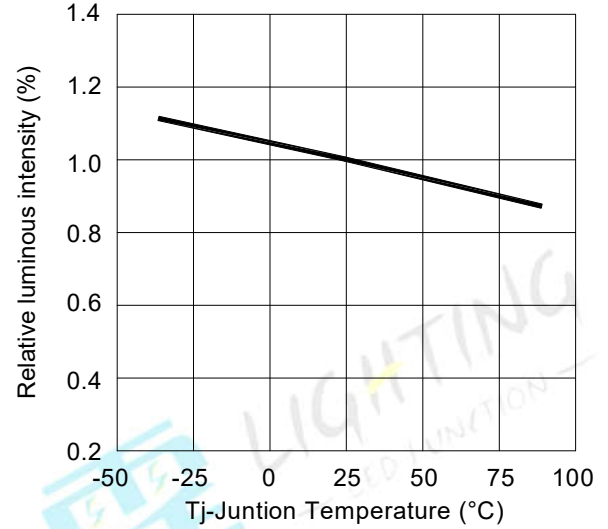
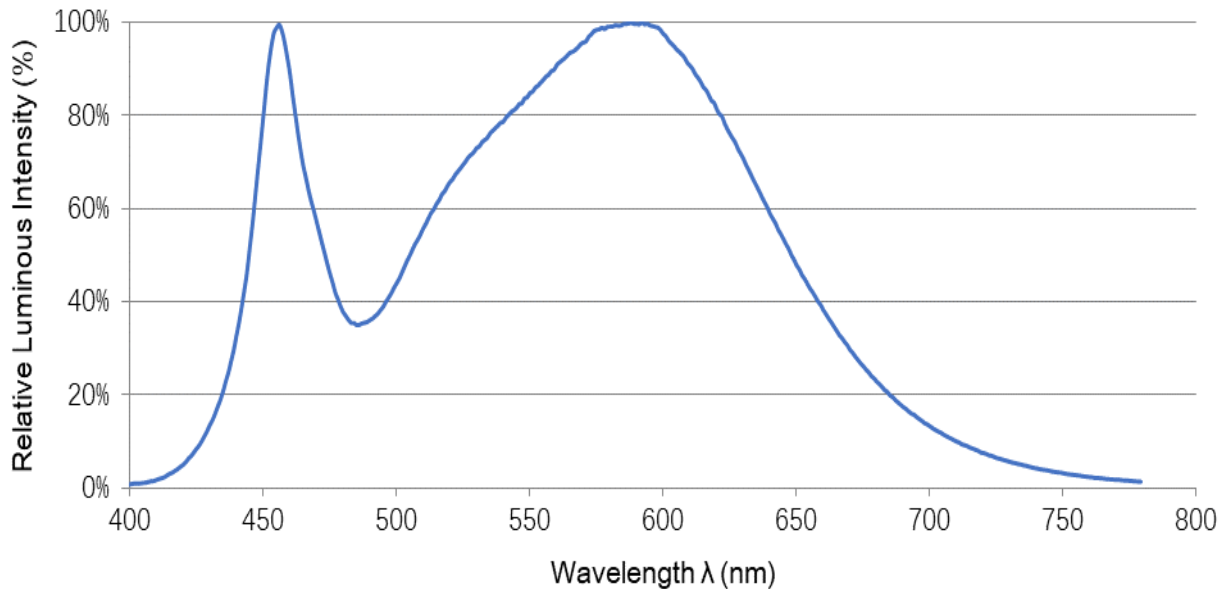

Fig.6-Relative Luminous Flux vs. Junction Temperature



Spectrum Distribution



**Moisture Resistant Packing Materials
Label Explanation**



- QR code:
Contains all of the following information
- P/N: Product Number
- TYPE :Part NO.
- IV: Luminous Flux Rank
- HUE:Chromaticity Coordinates Rank
- VF: Forward Voltage Rank
- QTY: Packing Quantity
- LOT NO.: Lot Number

Taping method: Loaded Quantity 4,000 pcs Per Reel

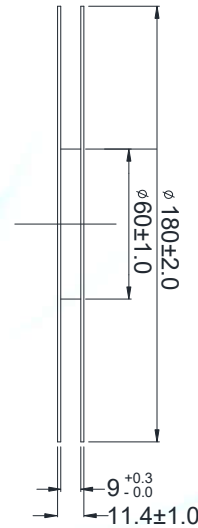
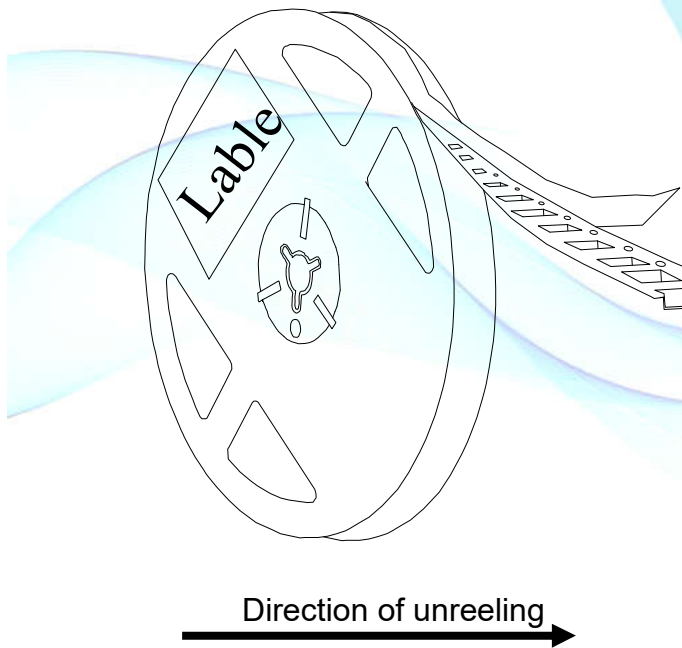

- Notes:
- 1.Tolerance unless mentioned is $\pm 0.1\text{mm}$,Unit = mm.
 - 2.Minimum packing amount is 1000 pcs per reel.

Carrier Tape Dimensions:

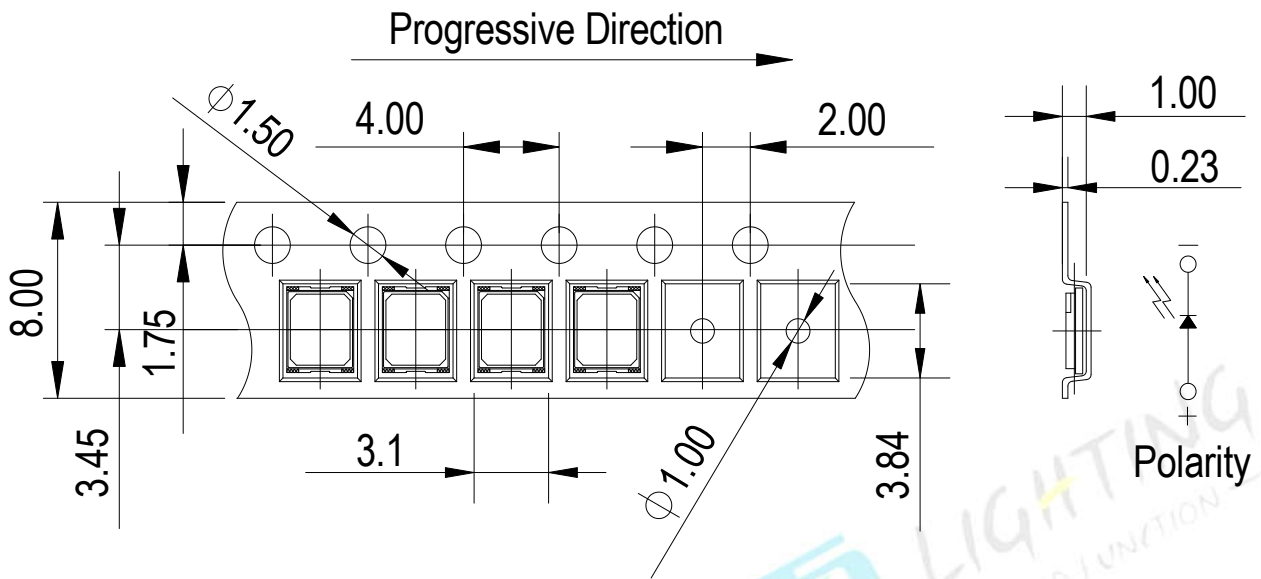

Note:
Tolerance unless mentioned is ± 0.1 mm, Unit = mm.

Moisture Resistant Packing Process

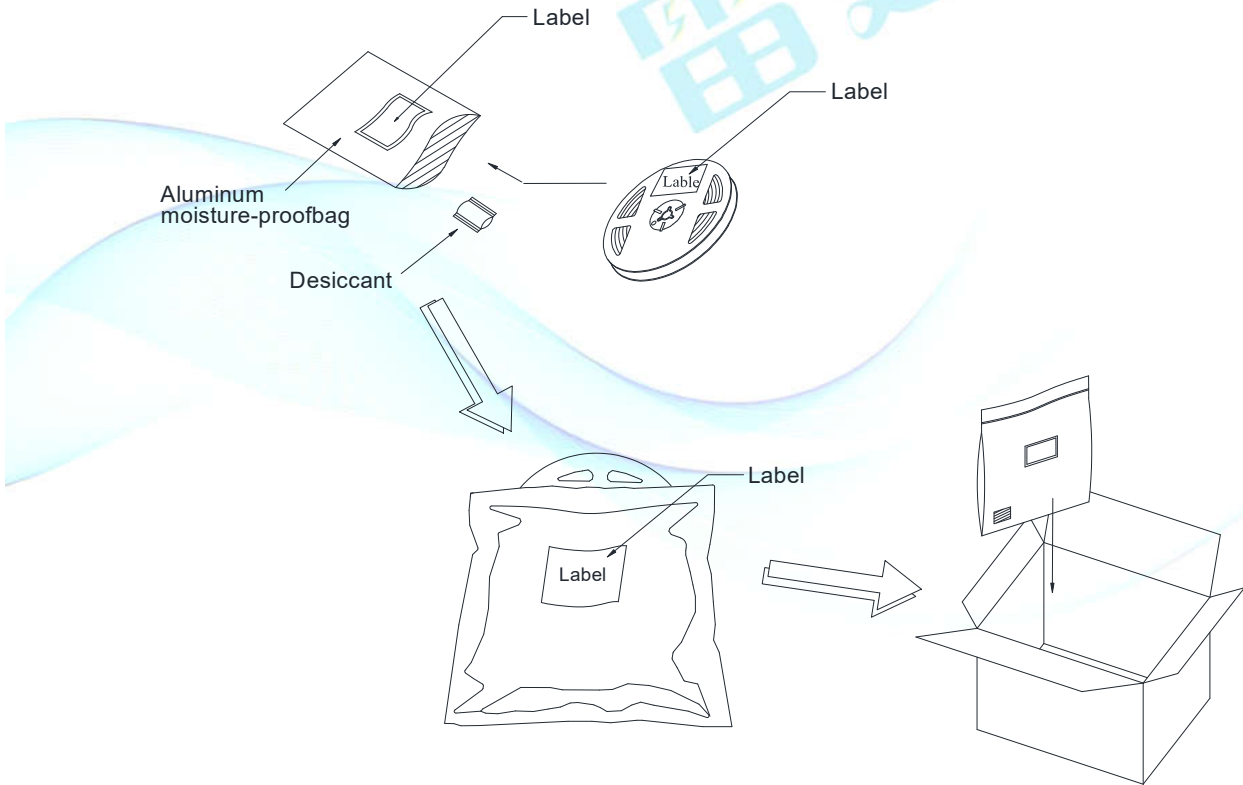

Moisture/Reflow sensitivity classification
IPC / JEDEC J-STD-020C: Level 5a

Reliability Test Items and Conditions

The reliability of products shall be satisfied with items listed below.

Confidence level : 90%

LTPD : 10%

No.	Items	Test Condition	Test Hours/Cycles	Sample Size	Ac/Re
1	Reflow Soldering	Temp.: 260°C/10sec.	6 Min.	22 PCS.	0/1
2	Thermal Shock	H : +100°C/5min ∫ 10 sec L : -10°C/5min	300 Cycles	22 PCS.	0/1
3	Temperature Cycle	H : +100°C/15min ∫ 5 min L : -40°C/15min	300 Cycles	22 PCS.	0/1
4	High Temperature/Humidity Storage	Ta=85°C,85%RH	1000 Hrs.	22 PCS.	0/1
5	Low Temperature Storage	Ta=-40°C	1000 Hrs.	22 PCS.	0/1
6	High Temperature Storage	Ta=100°C	1000 Hrs.	22 PCS.	0/1
7	DC Operation Life	Ta=25°C, I _F = 60 mA	1000 Hrs.	22 PCS.	0/1

Precautions for Use

1. Over-current-proof

Customer must apply resistors for protection; otherwise slight voltage shift will cause big current change (Burn out will happen).

2. Storage

2.1 Do not open moisture proof bag before the products are ready to use.

2.2 Before opening the package: The LEDs should be kept at 30°C or less and 90%RH or less.

2.3 After opening the package: The LED's floor life is 1 year under 30°C or less and 60%RH or less. If unused LEDs remain, it should be stored in moisture proof packages.

2.4 If the moisture absorbent material (silica gel) has faded away or the LEDs have exceeded the storage time, baking treatment should be performed using the following conditions.

Baking treatment: 60±5°C for 24 hours.

3. Soldering Condition

3.1 Pb-free solder temperature profile

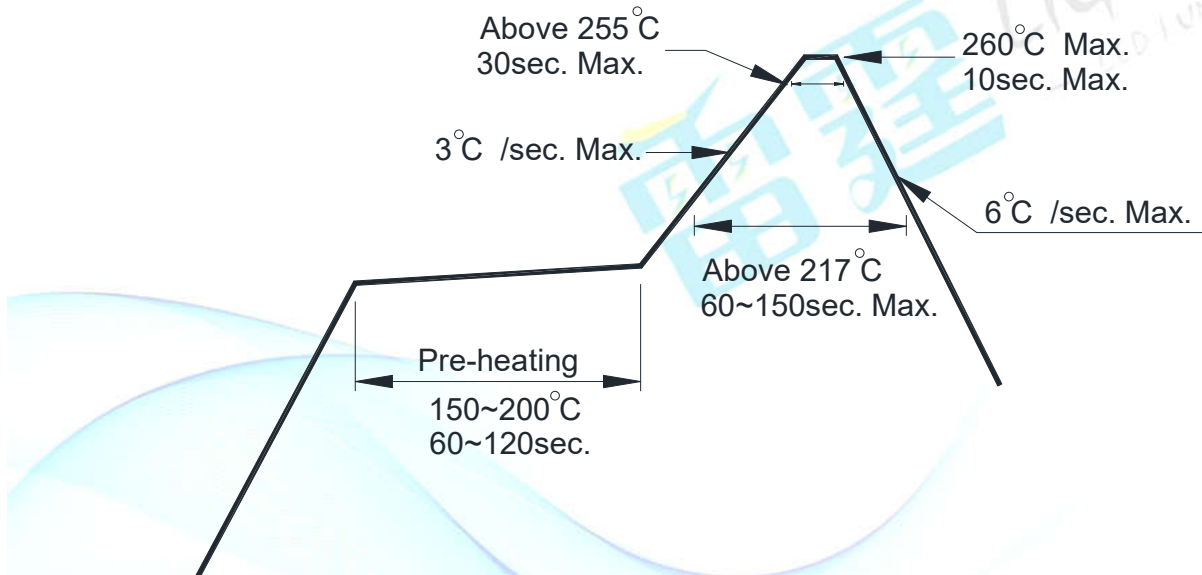

3.2 Reflow soldering should not be done more than two times.

3.3 When soldering, do not put stress on the LEDs during heating.

3.4 After soldering, do not warp the circuit board.

4. Soldering Iron

Each terminal is to go to the tip of soldering iron temperature less than 350°C for 3 seconds within once in less than the soldering iron capacity 25W. Leave two seconds and more intervals and do soldering of each terminal. Be careful because the damage of the product is often started at the time of the hand solder.

5. Repairing

Repair should not be done after the LEDs have been soldered. When repairing is unavoidable, a double-head soldering iron should be used (as below figure). It should be confirmed beforehand whether the characteristics of the LEDs will or will not be damaged by repairing.