

|                          |
|--------------------------|
| <b>Customer Approved</b> |
|                          |
| <b>Date:</b>             |

**Part No.:**  
**LB1943R6GHB1W-C01T2R**

**DATA SHEET**

Issue Date: 2018.09.04  
Issue No.: LTD-1943-004  
REVISION: V3

| Designer    | Checker     | Approver     |
|-------------|-------------|--------------|
| <i>Lisa</i> | <i>Rock</i> | <i>Allen</i> |

## Multi-Color Type ■ Top View 1615 Package LB1943R6GHB1W-C01T2R

### Features

- Top view 1615 package
- Wide viewing angle
- Compatible with infrared and vapor phase reflow solder process
- Pb-free
- RoHS compliant

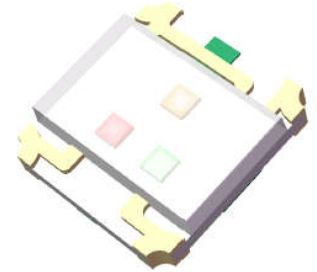

### Package Dimensions

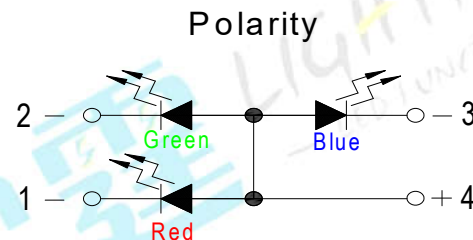
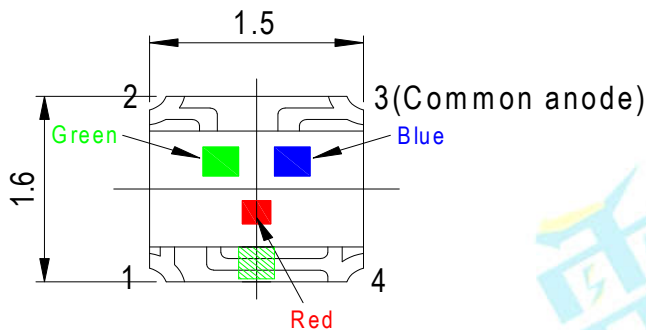

#### Recommended Solder Pad(1)

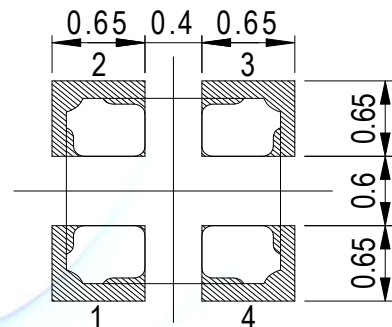

#### Recommended Solder Pad(2)

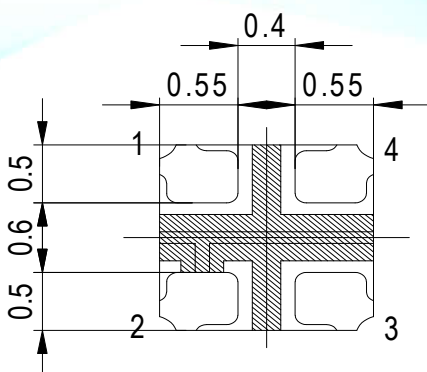
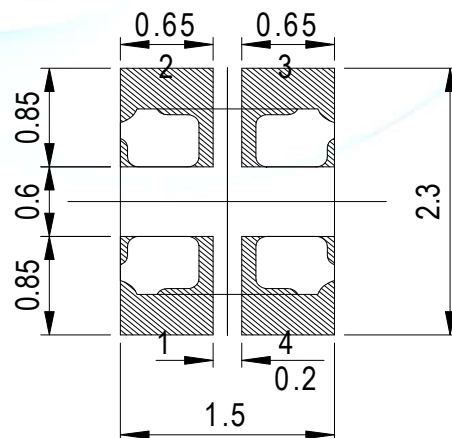

**Note:**

Tolerance unless mentioned is  $\pm 0.1$ mm, Unit = mm.

## Applications

- Indoor signage display applications
- Indoor decorating and design
- Signal and Symbol Luminary
- Automotive Telecommunication
- Switch lights

## Device Selection Guide

| Emitted Color  | Resin Color    |
|----------------|----------------|
| Red\Green\Blue | White Diffused |

## Absolute Maximum Ratings (T<sub>Soldering</sub>=25°C)

| Parameter                             | Symbol           | Rating  | Unit |
|---------------------------------------|------------------|---|------|
| Forward Current                       | I <sub>F</sub>   | 25  | mA   |
| Peak Forward Current (Duty 1/10 @1ms) | I <sub>FP</sub>  | 60  | mA   |
| Power Dissipation                     | P <sub>d</sub>   | Red:60  | mW   |
|                                       |                  | Green:95  | mW   |
|                                       |                  | Blue:95   | mW   |
| Operating Temperature                 | T <sub>opr</sub> | -40 ~ +85   | °C   |
| Storage Temperature                   | T <sub>stg</sub> | -40 ~ +100  | °C   |
| Soldering Temperature                 | T <sub>sol</sub> | Reflow Soldering : 260°C for 10 sec.<br>Hand Soldering : 350°C for 3 sec. |      |
| Reverse Voltage                       | V <sub>R</sub>   | 5   | V    |

**Electro-Optical Characteristics (T<sub>Soldering</sub>=25°C)**

| Parameter           | Symbol            | Color | Min. | Typ. | Max. | Unit | Condition           |
|---------------------|-------------------|-------|------|------|------|------|---------------------|
| Luminous Intensity  | I <sub>V</sub>    | Red   | 36   | --   | 90   | mcd  | I <sub>F</sub> =5mA |
|                     |                   | Green | 140  | --   | 565  | mcd  |                     |
|                     |                   | Blue  | 36   | --   | 90   | mcd  |                     |
| Dominant Wavelength | λ <sub>D</sub>    | Red   | --   | 622  | --   | nm   | I <sub>F</sub> =5mA |
|                     |                   | Green | 520  | --   | 535  | nm   |                     |
|                     |                   | Blue  | 465  | --   | 475  | nm   |                     |
| Forward Voltage     | V <sub>F</sub>    | Red   | 1.6  | --   | 2.1  | V    | I <sub>F</sub> =5mA |
|                     |                   | Green | 2.5  | --   | 3.1  | V    |                     |
|                     |                   | Blue  | 2.5  | --   | 3.1  | V    |                     |
| Viewing Angle       | 2θ <sub>1/2</sub> |       | -    | 130  | -    | deg  | I <sub>F</sub> =5mA |
| Reverse Current     | I <sub>R</sub>    | Red   | -    | -    | 1    | μA   | V <sub>R</sub> =5V  |
|                     |                   | Green | -    | -    | 1    | μA   |                     |
|                     |                   | Blue  | -    | -    | 1    | μA   |                     |

Notes:

1. Tolerance of Luminous Intensity ±10%.
2. Tolerance of Dominant Wavelength: ±1nm.
3. Tolerance of Forward Voltage: ±0.1V.

### Bin Code Description

Red: Bin Range of Luminous Intensity

| Bin Code | Min. | Max. | Unit | Condition           |
|----------|------|------|------|---------------------|
| NA       | 36   | 57   | mcd  | I <sub>F</sub> =5mA |
| PA       | 57   | 90   |      |                     |

Green: Bin Range of Luminous Intensity

| Bin Code | Min. | Max. | Unit | Condition           |
|----------|------|------|------|---------------------|
| RA       | 140  | 225  | mcd  | I <sub>F</sub> =5mA |
| SA       | 225  | 360  |      |                     |
| TA       | 360  | 565  |      |                     |

Blue: Bin Range of Luminous Intensity

| Bin Code | Min. | Max. | Unit | Condition           |
|----------|------|------|------|---------------------|
| NA       | 36   | 57   | mcd  | I <sub>F</sub> =5mA |
| PA       | 57   | 90   |      |                     |

Note:

Tolerance of Luminous Intensity: ±10%.

Green: Bin Range of Dominant Wavelength

| Bin Code | Min. | Max. | Unit | Condition           |
|----------|------|------|------|---------------------|
| A5       | 520  | 525  | nm   | I <sub>F</sub> =5mA |
| A6       | 525  | 530  |      |                     |
| A7       | 530  | 535  |      |                     |

Blue: Bin Range of Dominant Wavelength

| Bin Code | Min. | Max. | Unit | Condition           |
|----------|------|------|------|---------------------|
| A6       | 465  | 470  | nm   | I <sub>F</sub> =5mA |
| A7       | 470  | 475  |      |                     |

Note:

Tolerance of Dominant Wavelength: ±1nm.

**Typical Electro-Optical Characteristics Curves**

Fig.1-Forward Current(V) vs. Forward Voltage  $T_s=25^\circ\text{C}$

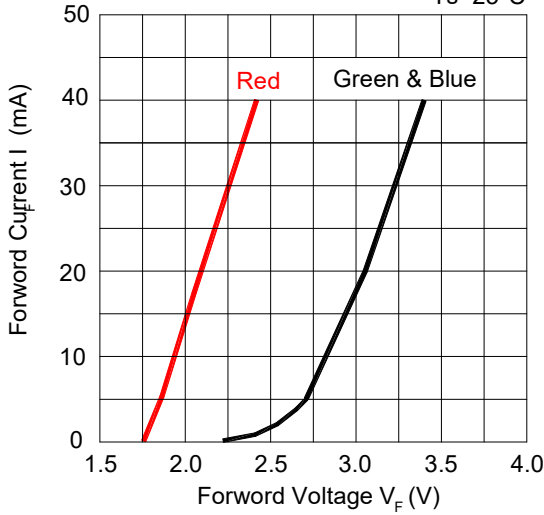

Fig.2-Relative Luminous Intensity vs. Forward Current  $T_s=25^\circ\text{C}$

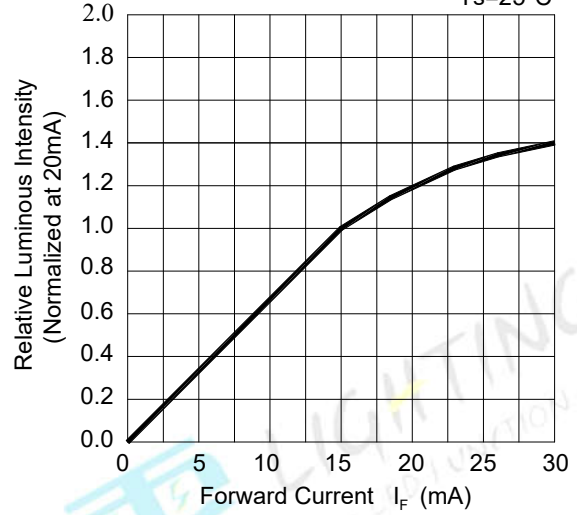

Fig.3-Max.Driving Forward Current vs.Soldering Temperature

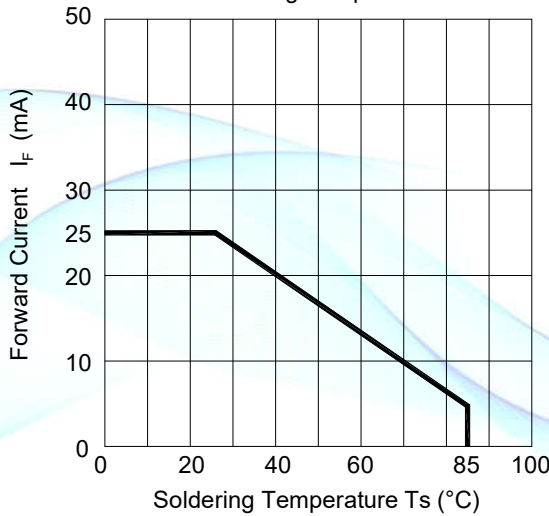
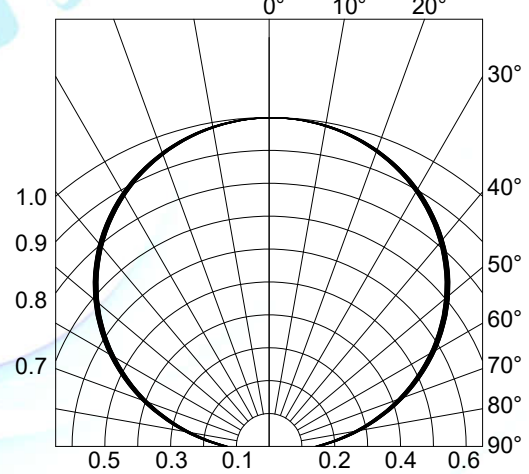

Fig.4-Radiation Diagram  $T_a=25^\circ\text{C}$



### Typical Electro-Optical Characteristics Curves

Fig.5-Forward Voltage Shift vs. Junction Temperature

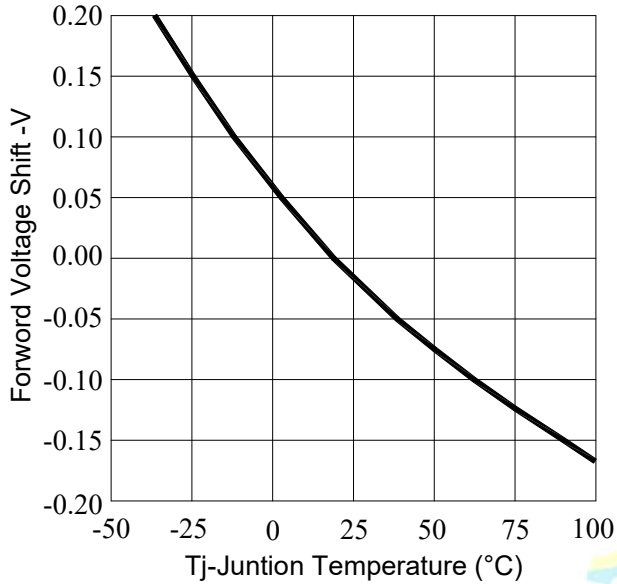
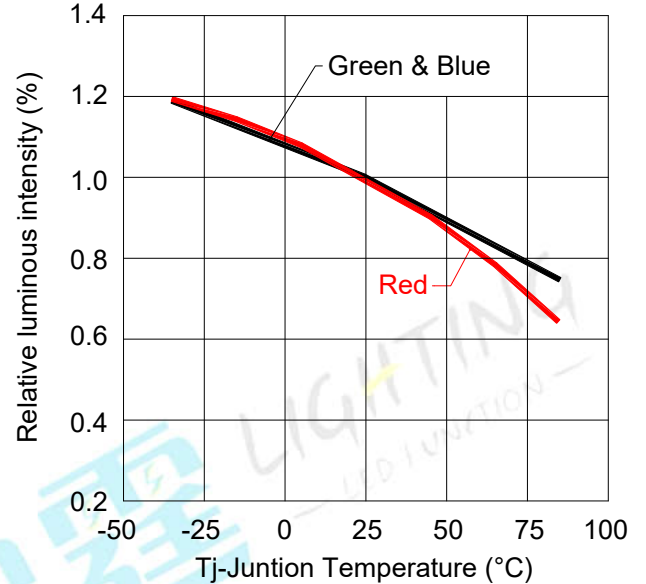
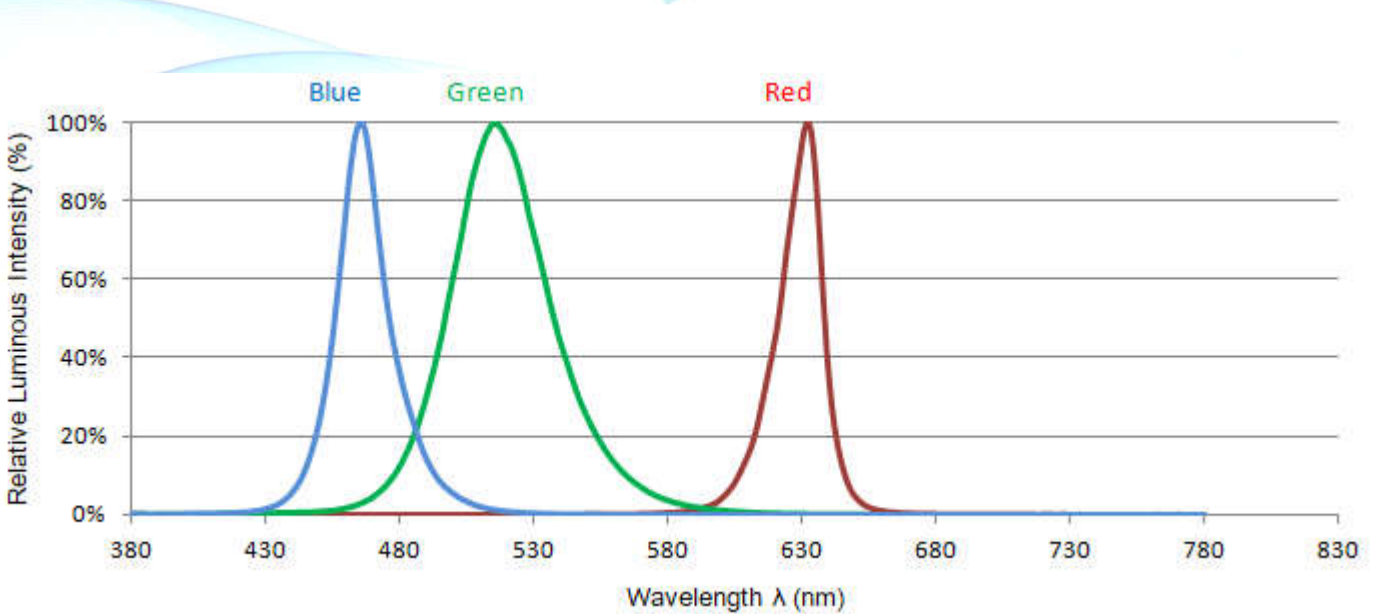

Fig.6-Relative Luminous Intensity vs. Junction Temperature



### Spectrum Distribution



**Moisture Resistant Packing Materials  
Label Explanation**



- QR code:  
Contains all of the following information
- P/N: Product Number
- TYPE :Part NO.
- IV: Luminous Intensity Rank
- WD: Dom. Wavelength Rank
- VF: Forward Voltage Rank
- QTY: Packing Quantity
- LOT NO.: Lot Number

Taping method: Loaded Quantity 2,000 pcs Per Reel

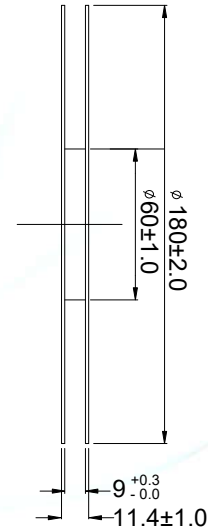
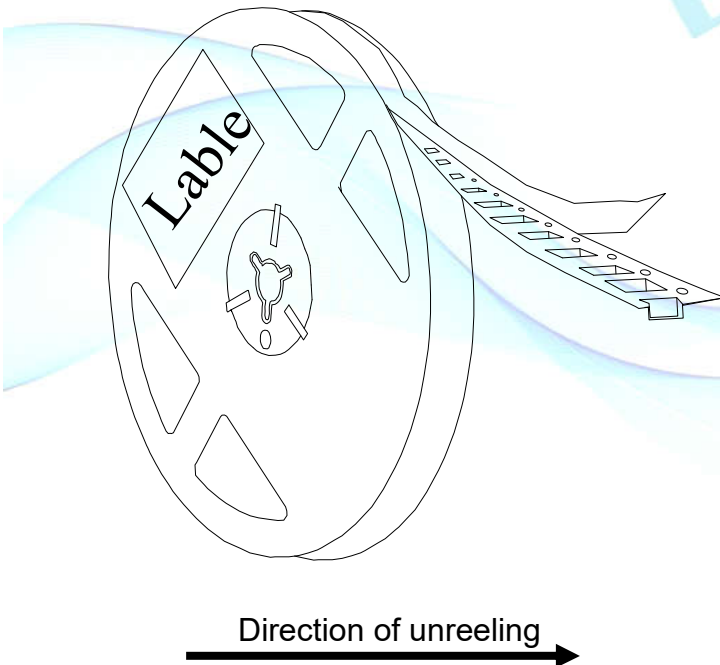

- Notes:
1. Tolerance unless mentioned is  $\pm 0.1$ mm, Unit = mm.
  2. Minimum packing amount is 1000 pcs per reel.



**Carrier Tape Dimensions:**

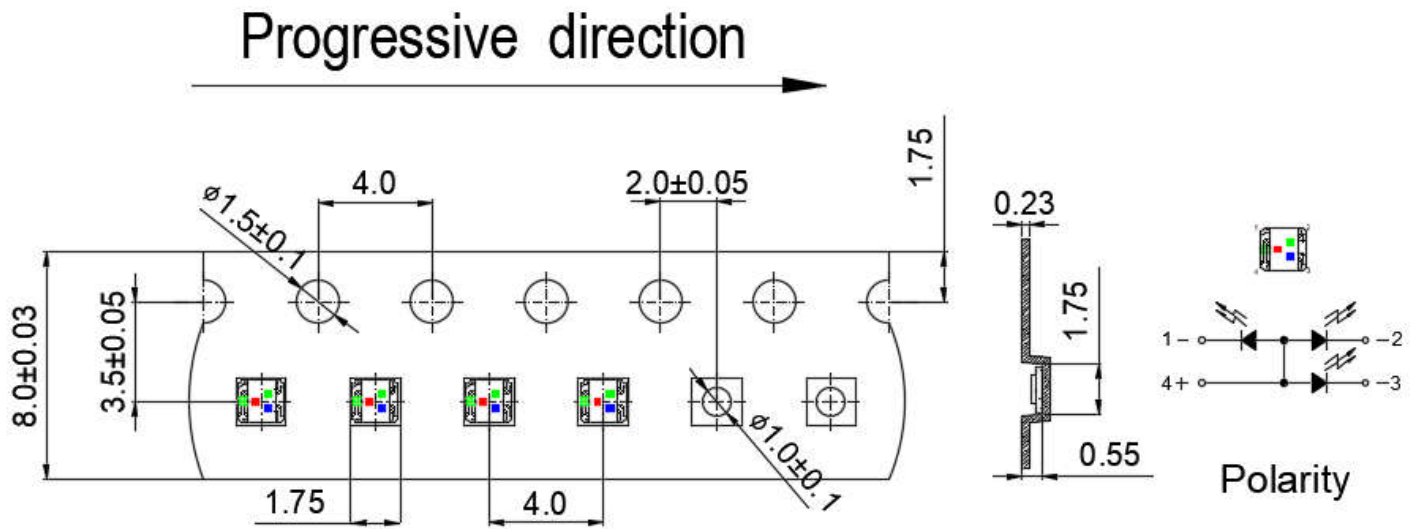

Note:  
Tolerance unless mentioned is  $\pm 0.1$ mm, Unit = mm

**Moisture Resistant Packing Process**

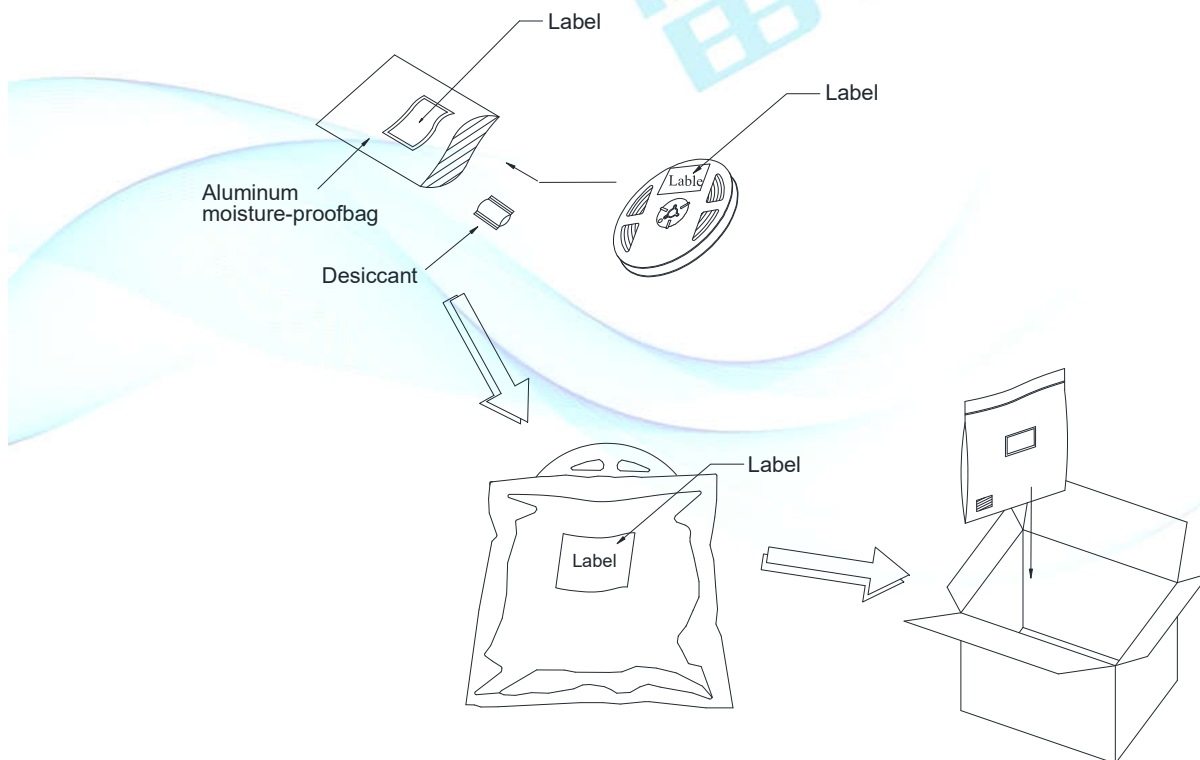

Moisture/Reflow sensitivity classification  
IPC / JEDEC J-STD-020C: Level 2

## Reliability Test Items and Conditions

The reliability of products shall be satisfied with items listed below.

Confidence level : 90%

LTPD : 10%

| No. | Items                             | Test Condition                                 | Test Hours/Cycles | Sample Size | Ac/Re |
|-----|-----------------------------------|--|-------------------|-------------|-------|
| 1   | Reflow Soldering                  | Temp.: 260°C/10sec.                            | 6 Min.            | 22 PCS.     | 0/1   |
| 2   | Thermal Shock                     | H : +100°C/5min<br>∫ 10 sec<br>L : -10°C/5min  | 300 Cycles        | 22 PCS.     | 0/1   |
| 3   | Temperature Cycle                 | H : +100°C/15min<br>∫ 5 min<br>L : -40°C/15min | 300 Cycles        | 22 PCS.     | 0/1   |
| 4   | High Temperature/Humidity Storage | Ta=85°C,85%RH                                  | 1000 Hrs.         | 22 PCS.     | 0/1   |
| 5   | Low Temperature Storage           | Ta=-40°C                                       | 1000 Hrs.         | 22 PCS.     | 0/1   |
| 6   | High Temperature Storage          | Ta=100°C                                       | 1000 Hrs.         | 22 PCS.     | 0/1   |
| 7   | DC Operation Life                 | Ta=25°C,<br>I <sub>F</sub> = 5 mA              | 1000 Hrs.         | 22 PCS.     | 0/1   |

## Precautions for Use

### 1. Over-current-proof

Customer must apply resistors for protection; otherwise slight voltage shift will cause big current change (Burn out will happen).

### 2. Storage

2.1 Do not open moisture proof bag before the products are ready to use.

2.2 Before opening the package: The LEDs should be kept at 30°C or less and 90%RH or less.

2.3 After opening the package: The LED's floor life is 1 year under 30°C or less and 60%RH or less. If unused LEDs remain, it should be stored in moisture proof packages.

2.4 If the moisture absorbent material (silica gel) has faded away or the LEDs have exceeded the storage time, baking treatment should be performed using the following conditions.

Baking treatment: 60±5°C for 24 hours.

### 3. Soldering Condition

#### 3.1 Pb-free solder temperature profile

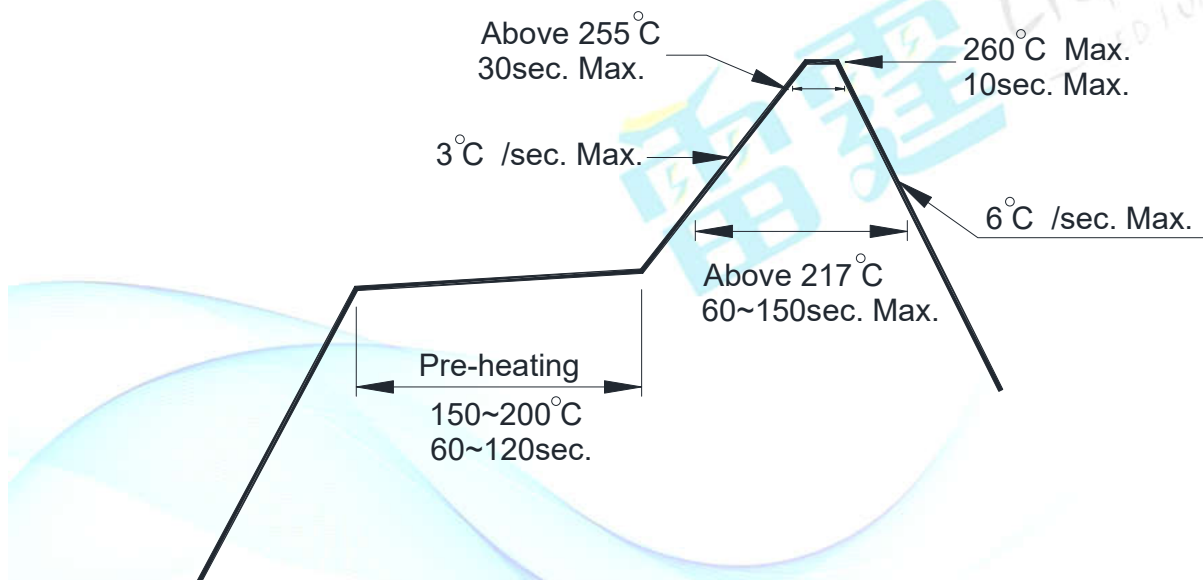

3.2 Reflow soldering should not be done more than two times.

3.3 When soldering, do not put stress on the LEDs during heating.

3.4 After soldering, do not warp the circuit board.

### 4. Soldering Iron

Each terminal is to go to the tip of soldering iron temperature less than 350°C for 3 seconds within once in less than soldering iron capacity 25W. Leave two seconds and more intervals and do soldering of each terminal. Be careful because the damage of the product is often started at the time of the hand solder.

### 5. Repairing

Repair should not be done after the LEDs have been soldered. When repairing is unavoidable, a double-head soldering iron should be used (as below figure). It should be confirmed beforehand whether the characteristics of the LEDs will or will not be damaged by repairing.