

Customer Approved
Date:

Part No.:
LB1943R6GHB1W-C01T2

DATA SHEET

Issue Date: 2017.06.08
Issue No.: LTD-1943-001
REVISION: V2

Designer	Checker	Approver
<i>Lisa</i>	<i>Rock</i>	<i>Allen</i>

Multi-Color Type ■ Top View 1615 Package LB1943R6GHB1W-C01T2

Features

- Top view 1615 package
- Wide viewing angle
- Compatible with infrared and vapor phase reflow solder process
- Pb-free
- RoHS compliant

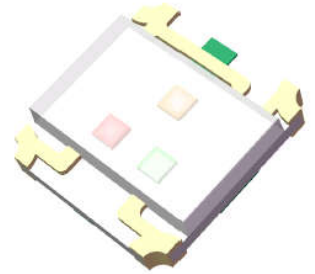

Package Dimensions

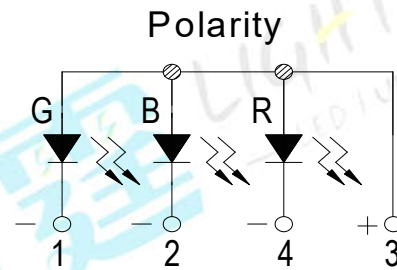
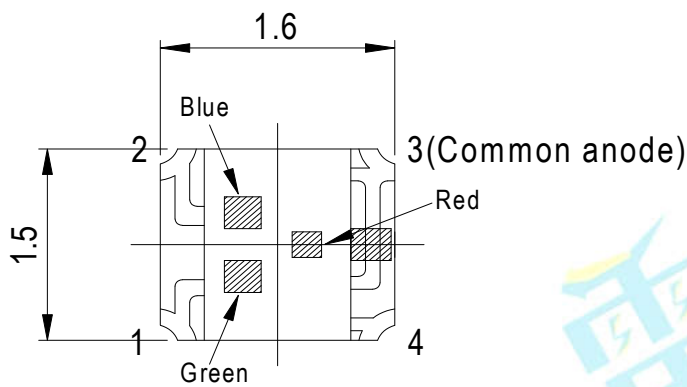

Recommended Solder Pad(1)

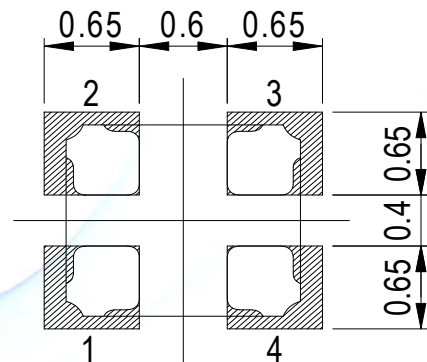

Recommended Solder Pad(2)

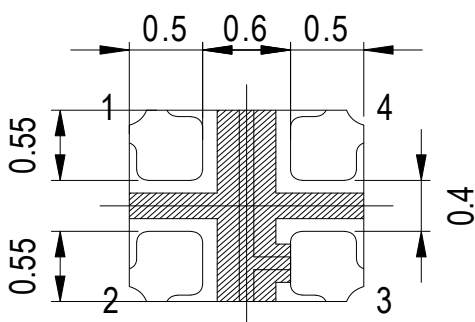
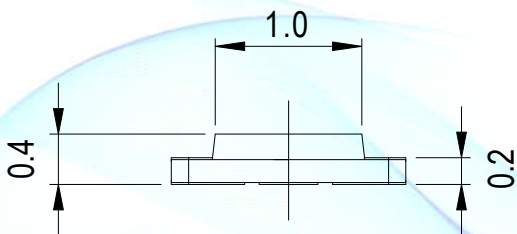
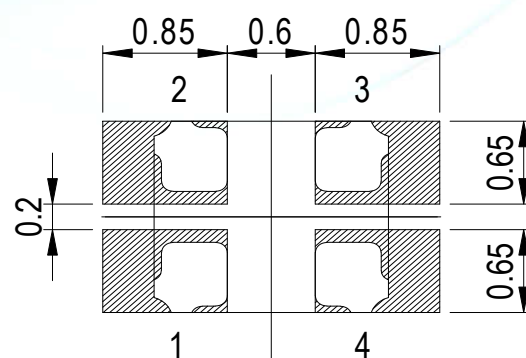

Note:

Tolerance unless mentioned is ± 0.1 mm, Unit = mm.

Applications

- Indoor signage display applications
- Indoor decorating and design
- Signal and Symbol Luminary
- Automotive Telecommunication
- Switch lights

Device Selection Guide

Emitted Color	Resin Color
Red\Green\Blue	White Diffused

Absolute Maximum Ratings (T_{Soldering}=25°C)

Parameter	Symbol	Rating	Unit
Forward Current	I _F	25	mA
Peak Forward Current (Duty 1/10 @1ms)	I _{FP}	60	mA
Power Dissipation	P _d	Red:60	mW
		Green:95	mW
		Blue:95	mW
Operating Temperature	T _{opr}	-40 ~ +85	°C
Storage Temperature	T _{stg}	-40 ~ +100	°C
Soldering Temperature	T _{sol}	Reflow Soldering : 260°C for 10 sec. Hand Soldering : 350°C for 3 sec.	
Reverse Voltage	V _R	5	V

Note:

The products are sensitive to static electricity and must be carefully taken when handling products.

Electro-Optical Characteristics (T_{Soldering}=25°C)

Parameter	Symbol	Color	Min.	Typ.	Max.	Unit	Condition
Luminous Intensity	I _V	Red	36	--	90	mcd	I _F =5mA
		Green	140	--	565	mcd	
		Blue	36	--	90	mcd	
Dominant Wavelength	λ _D	Red	617	622	627	nm	I _F =5mA
		Green	520	527	535	nm	
		Blue	465	470	475	nm	
Forward Voltage	V _F	Red	1.6	--	2.1	V	I _F =5mA
		Green	2.4	--	3.0	V	
		Blue	2.5	--	3.1	V	
Viewing Angle	2θ _{1/2}		-	130	-	deg	I _F =5mA
Reverse Current	I _R	Red	-	-	1	μA	V _R =5V
		Green	-	-	1	μA	
		Blue	-	-	1	μA	

Notes:

1. Tolerance of Luminous Intensity ±10%.
2. Tolerance of Dominant Wavelength: ±1nm.
3. Tolerance of Forward Voltage: ±0.1V.

Bin Code Description

Red: Bin Range of Luminous Intensity

Bin Code	Min.	Max.	Unit	Condition
NA	36	57	mcd	I _F =5mA
PA	57	90		

Green: Bin Range of Luminous Intensity

Bin Code	Min.	Max.	Unit	Condition
RA	140	225	mcd	I _F =5mA
SA	225	360		
TA	360	565		

Blue: Bin Range of Luminous Intensity

Bin Code	Min.	Max.	Unit	Condition
NA	36	57	mcd	I _F =5mA
PA	57	90		

Note:

Tolerance of Luminous Intensity: ±10%.

Green: Bin Range of Dominant Wavelength

Bin Code	Min.	Max.	Unit	Condition
A5	520	525	nm	I _F =5mA
A6	525	530		
A7	530	535		

Blue: Bin Range of Dominant Wavelength

Bin Code	Min.	Max.	Unit	Condition
A6	465	470	nm	I _F =5mA
A7	470	475		

Note:

Tolerance of Dominant Wavelength: ±1nm.

Typical Electro-Optical Characteristics Curves

Fig.1-Forward Current(V) vs. Forward Voltage $T_s=25^\circ\text{C}$

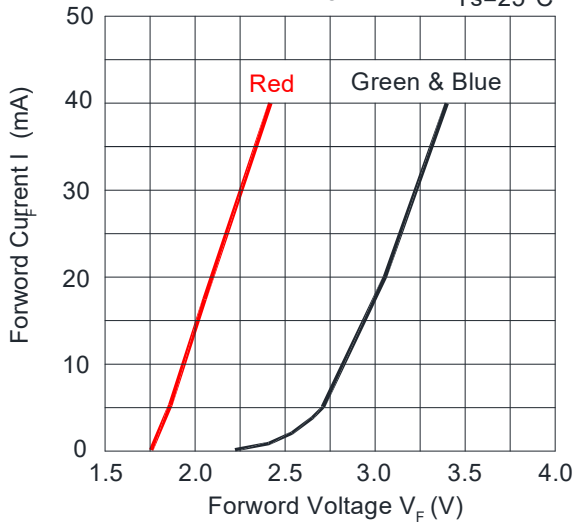

Fig.2-Relative Luminous Intensity vs. Forward Current $T_s=25^\circ\text{C}$

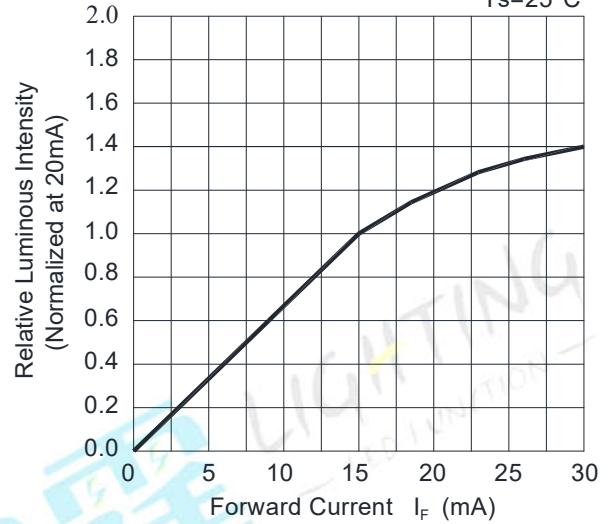

Fig.3-Max. Driving Forward Current vs. Soldering Temperature

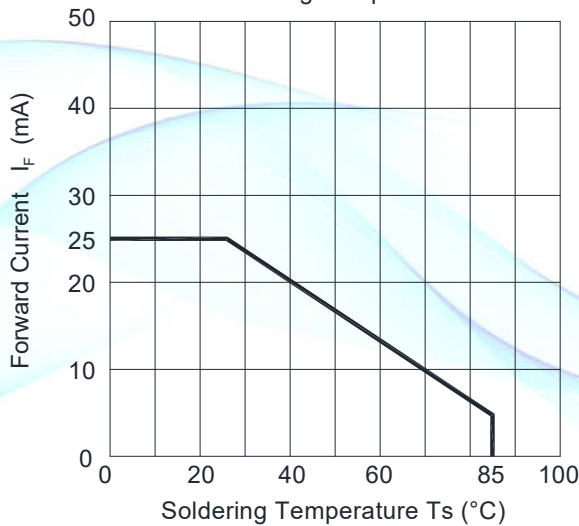
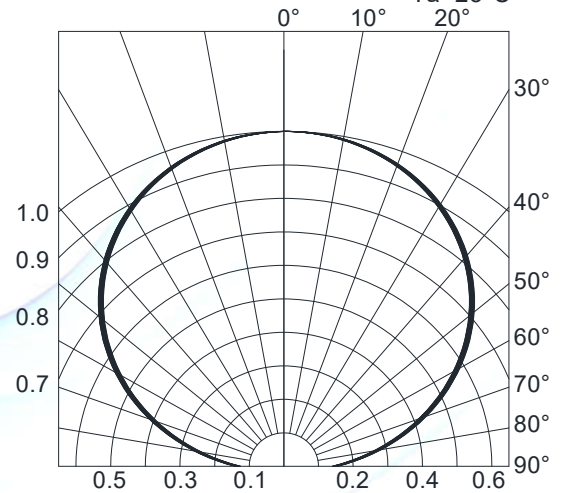

Fig.4-Radiation Diagram $T_a=25^\circ\text{C}$



Typical Electro-Optical Characteristics Curves

Fig.5-Forward Voltage Shift vs. Junction Temperature

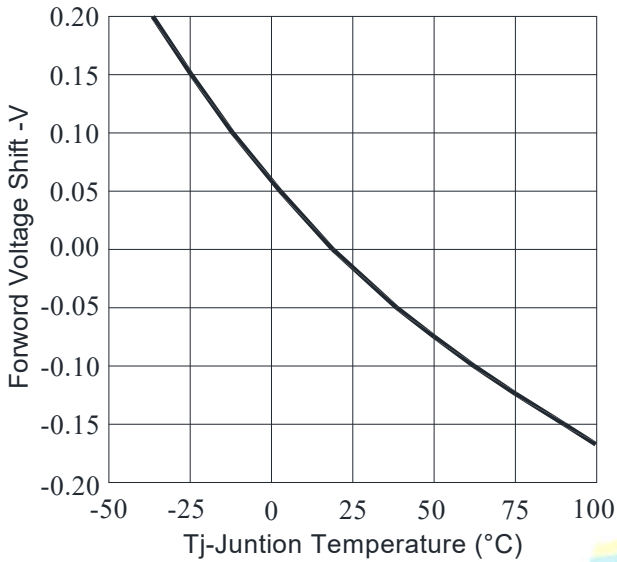
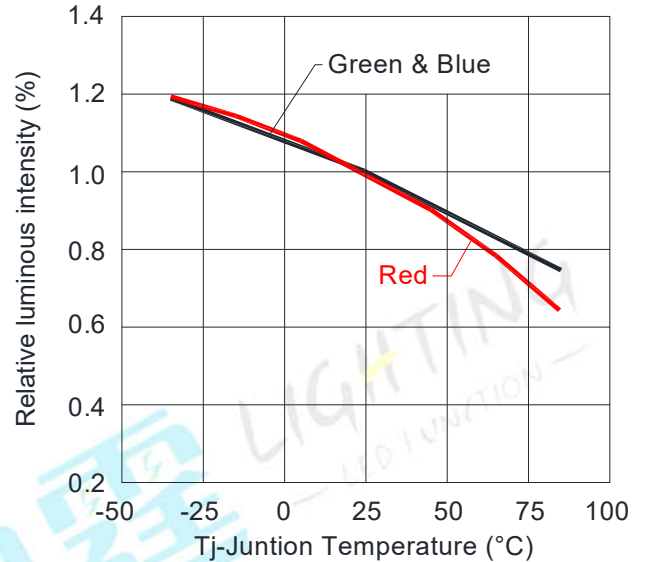
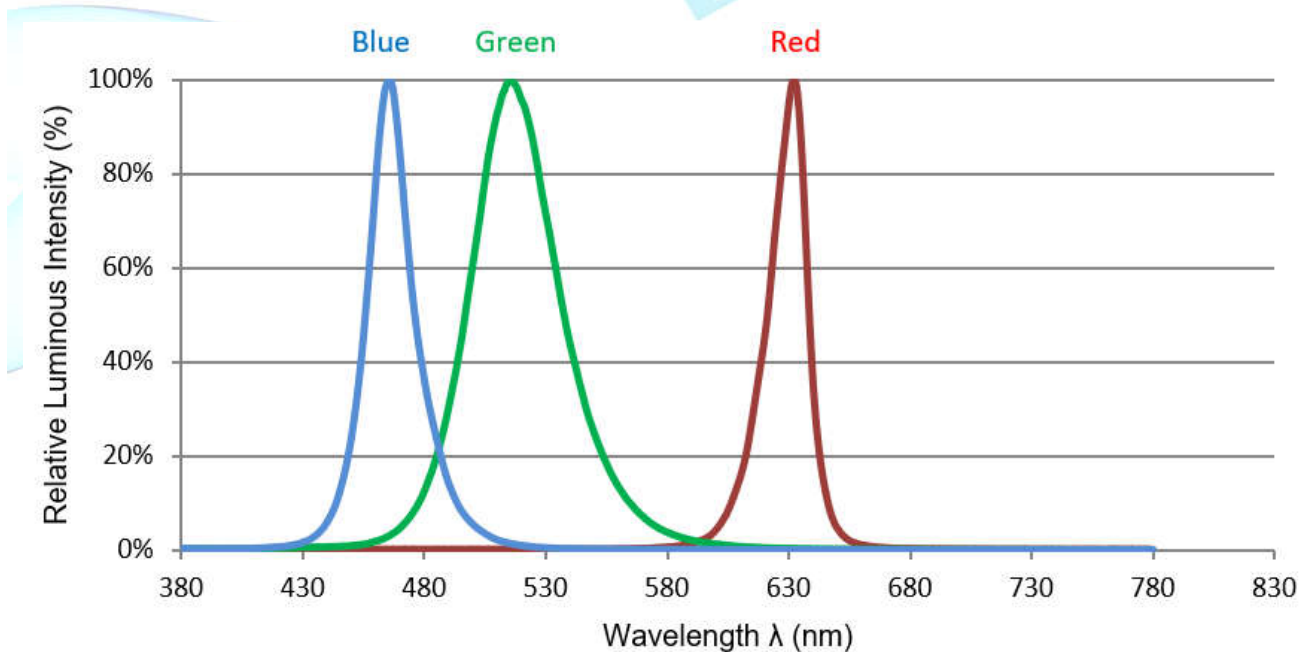

Fig.6-Relative Luminous Intensity vs. Junction Temperature



Spectrum Distribution



**Moisture Resistant Packing Materials
Label Explanation**



- QR code:
Contains all of the following information
- P/N: Product Number
- TYPE :Part NO.
- IV: Luminous Intensity Rank
- WD: Dom. Wavelength Rank
- VF: Forward Voltage Rank
- QTY: Packing Quantity
- LOT NO.: Lot Number

Taping method: Loaded Quantity 2,000 pcs Per Reel

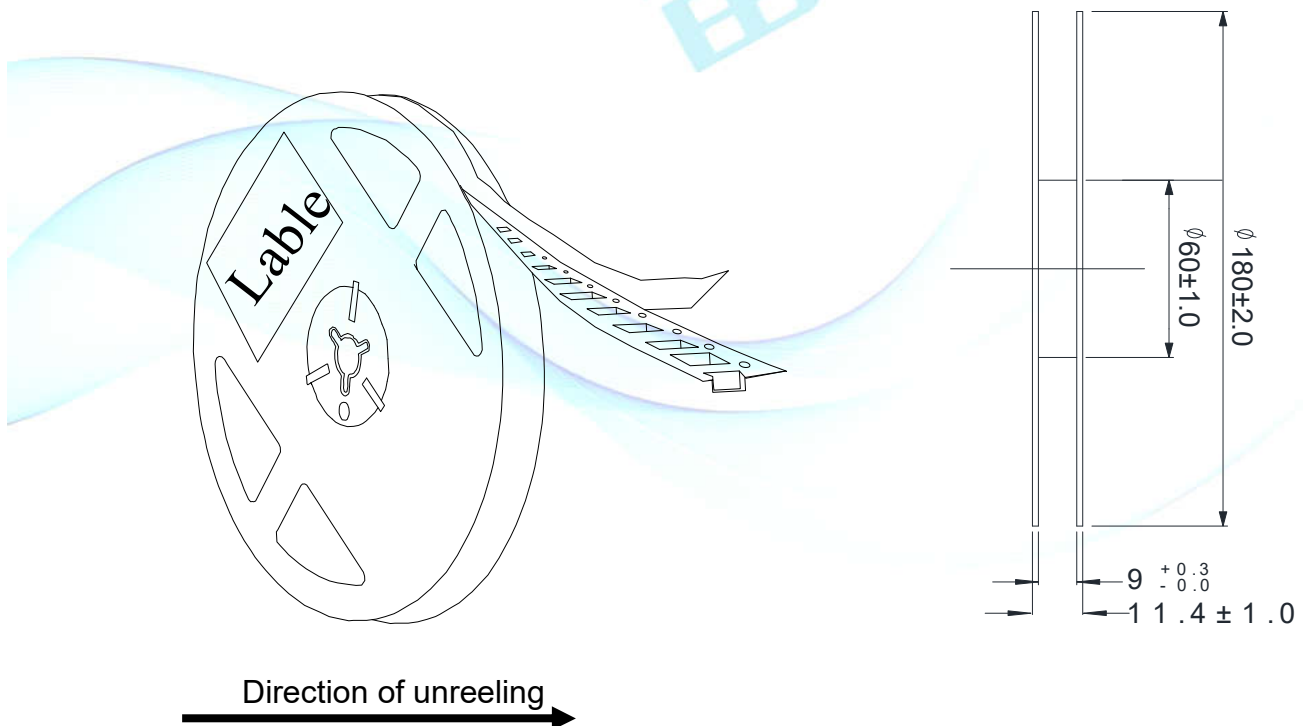

- Notes:
1. Tolerance unless mentioned is ± 0.1 mm, Unit = mm.
 2. Minimum packing amount is 1000 pcs per reel.

Carrier Tape Dimensions:

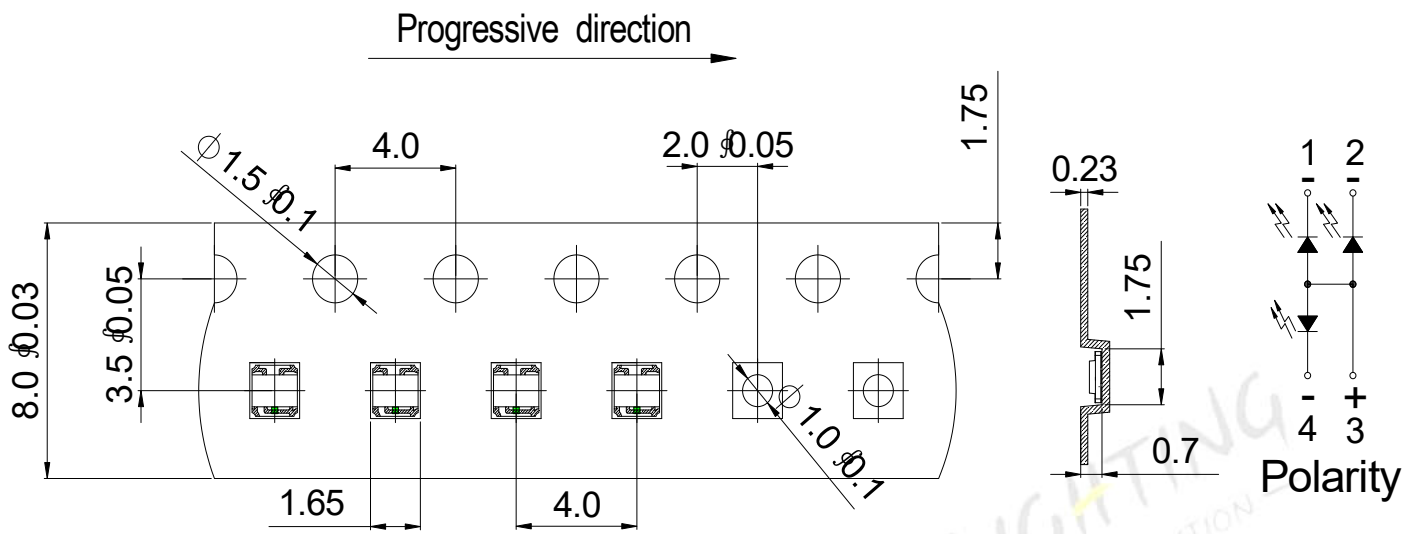

Note:
Tolerance unless mentioned is ±0.1mm, Unit = mm.

Moisture Resistant Packing Process

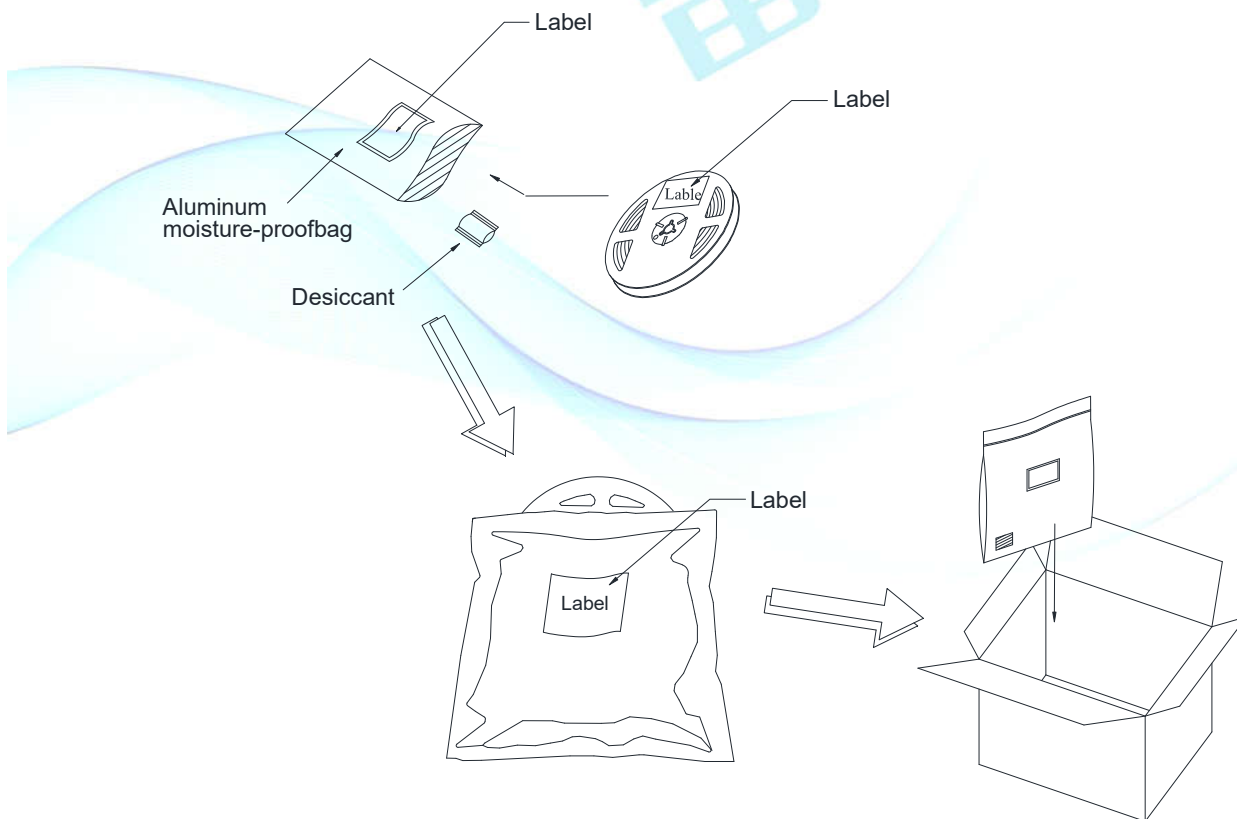

Moisture/Reflow sensitivity classification

IPC / JEDEC J-STD-020C: Level 2

Reliability Test Items and Conditions

The reliability of products shall be satisfied with items listed below.

Confidence level : 90%

LTPD : 10%

No.	Items	Test Condition	Test Hours/Cycles	Sample Size	Ac/Re
1	Reflow Soldering	Temp.: 260°C/10sec.	6 Min.	22 PCS.	0/1
2	Thermal Shock	H : +100°C/5min ∫ 10 sec L : -10°C/5min	300 Cycles	22 PCS.	0/1
3	Temperature Cycle	H : +100°C/15min ∫ 5 min L : -40°C/15min	300 Cycles	22 PCS.	0/1
4	High Temperature/Humidity Storage	Ta=85°C,85%RH	1000 Hrs.	22 PCS.	0/1
5	Low Temperature Storage	Ta=-40°C	1000 Hrs.	22 PCS.	0/1
6	High Temperature Storage	Ta=100°C	1000 Hrs.	22 PCS.	0/1
7	DC Operation Life	Ta=25°C, I _F = 5 mA	1000 Hrs.	22 PCS.	0/1

Precautions for Use

1. Over-current-proof

Customer must apply resistors for protection; otherwise slight voltage shift will cause big current change (Burn out will happen).

2. Storage

2.1 Do not open moisture proof bag before the products are ready to use.

2.2 Before opening the package: The LEDs should be kept at 30°C or less and 90%RH or less.

2.3 After opening the package: The LED's floor life is 1 year under 30°C or less and 60%RH or less. If unused LEDs remain, it should be stored in moisture proof packages.

2.4 If the moisture absorbent material (silica gel) has faded away or the LEDs have exceeded the storage time, baking treatment should be performed using the following conditions.

Baking treatment: 60±5°C for 24 hours.

3. Soldering Condition

3.1 Pb-free solder temperature profile

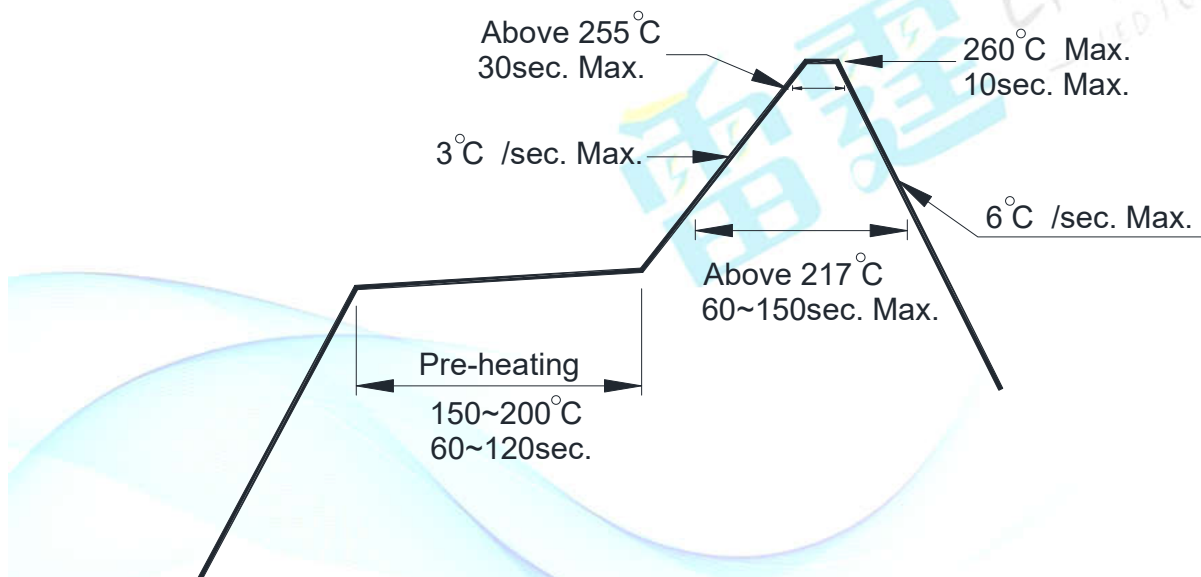

3.2 Reflow soldering should not be done more than two times.

3.3 When soldering, do not put stress on the LEDs during heating.

3.4 After soldering, do not warp the circuit board.

4. Soldering Iron

Each terminal is to go to the tip of soldering iron temperature less than 350°C for 3 seconds within once in less than the soldering iron capacity 25W. Leave two seconds and more intervals and do soldering of each terminal. Be careful because the damage of the product is often started at the time of the hand solder.

5. Repairing

Repair should not be done after the LEDs have been soldered. When repairing is unavoidable, a double-head soldering iron should be used (as below figure). It should be confirmed beforehand whether the characteristics of the LEDs will or will not be damaged by repa